

## AIRPLANE FLIGHT MANUAL AQUILA AT01



LBA Approved in Normal Category based on JAR-VLA.

This Airplane Flight Manual must be carried on board of the aircraft at all times and be kept within the reach of the pilot during all flight operations. The amendment history and revision status of each section of the Airplane Flight Manual are provided in the list of effective pages and in the list of revisions.

This aircraft must be operated in compliance with the procedures and operating limits specified herein.

**SERIAL NO.:** AQUILA AT01-\_\_\_\_\_

**REGIST. NO.:** \_\_\_\_\_

Revision A.01 was approved by the Luftfahrt-Bundesamt (LBA) on 30/08/2002 within the scope of the type-certification. All revisions of section 2, 3, 4 and 5 beyond the scope of documentary changes are subject to EASA-approval.

|                              |                          |
|------------------------------|--------------------------|
| <b>Doc. No.</b>              | <b>FM-AT01-1010-100E</b> |
| <b>First Issued:</b>         | <b>05/06/2002</b>        |
| <b>Cover Page Issue No.:</b> | <b>A.18</b>              |

## INTRODUCTION

With the AQUILA AT01 you acquired a very efficient training and utility aircraft, which can be operated very easily and exhibit excellent handling qualities.

Reliable operation, handling and maintenance guarantee always trouble-free flights and continued airworthiness.

For that, we recommend to read this Airplane Flight Manual thoroughly and adhere to the operating instructions and recommendations given herein.

Furthermore, we recommend attending a type training course held by AQUILA company trained personnel to obtain a "feeling" for the optimal operation of the aircraft within a shorter period of time.

|             |
|-------------|
| <b>NOTE</b> |
|-------------|

All limitations, procedures and performance data contained in this handbook are EASA-/LBA-approved and mandatory. Not paying attention to the procedures and limits of the handbook can lead to a loss of liability by the manufacturer.

## THE HANDBOOK

The Airplane Flight Manual has been prepared using the recommendations of JAR-VLA Appendix H (issue 26/4/90) "Specimen Flight Manual for a Very Light Aeroplane".

The handbook is presented in loose-leaf form to ease the substitution of revisions and is sized in A5-format for convenient storage in the airplane. Tab dividers throughout the handbook allow quick reference to each section. Tables of Contents are located at the beginning of each section to aid locating specific data within that section.

All rights reserved.

Reproduction or disclosure to third parties of this document or any part thereof is not permitted, except with the prior and express written permission of the AQUILA Aviation by Excellence AG.

Copyright © by  AQUILA Aviation by Excellence AG  
Schönhausen, Germany

| <i>Dokument No.:</i> | <i>Issue:</i> | <i>Supersedes Issue:</i> | <i>Date:</i> | <i>Page:</i> |
|----------------------|---------------|--------------------------|--------------|--------------|
| FM-AT01-1010-100E    | A.18          | A.17 (07/10/2010)        | 29/11/2010   | 0 - 1        |

**TABLE OF CONTENTS**

|   | SECTION |
|---|---------|
| GENERAL                                     | 1       |
| OPERATING LIMITATIONS (an approved section) | 2       |
| EMERGENCY PROCEDURES (an approved section)  | 3       |
| NORMAL PROCEDURES (an approved section)     | 4       |
| PERFORMANCE (an partly approved section)    | 5       |
| WEIGHT AND BALANCE                          | 6       |
| DESCRIPTION OF THE AIRCRAFT AND ITS SYSTEMS | 7       |
| HANDLING, SERVICE AND MAINTENANCE           | 8       |
| SUPPLEMENTS                                 | 9       |

| <i>Dokument No.:</i> | <i>Issue:</i> | <i>Supersedes Issue:</i> | <i>Date:</i> | <i>Page:</i> |
|----------------------|---------------|--------------------------|--------------|--------------|
| FM-AT01-1010-100E    | A.18          | A.17 (07/10/2010)        | 29/11/2010   | 0 - 2        |

**LIST OF EFFECTIVE PAGES**

| Section | approved | Issue No. | Page        | Date       |
|---------|----------|-----------|-------------|------------|
| 0       |          | A.18      | 0-1 to 0-8  | 29/11/2010 |
| 1       |          | A.12      | 1-1 to 1-12 | 17/09/2008 |
| 2       | X        | A.12      | 2-1 to 2-20 | 17/09/2008 |
| 3       | X        | A.12      | 3-1 to 3-16 | 17/09/2008 |
| 4       | X        | A.18      | 4-1 to 4-20 | 29.11.2010 |
| 5       | (X)*     | A.12      | 5-1 to 5-23 | 17/09/2008 |
| 6       |          | A.12      | 6-1 to 6-14 | 17/09/2008 |
| 7       |          | A.14      | 7-1 to 7-32 | 03/09/2009 |
| 8       |          | A.12      | 8-1 to 8-8  | 17/09/2008 |
| 9       |          | A.17      | 9-1 to 9-3  | 07/10/2010 |

- - partly approved

| <i>Dokument No.:</i> | <i>Issue:</i> | <i>Supersedes Issue:</i> | <i>Date:</i> | <i>Page:</i> |
|----------------------|---------------|--------------------------|--------------|--------------|
| FM-AT01-1010-100E    | A.18          | A.17 (07/10/2010)        | 29/11/2010   | 0 - 3        |

**LIST OF REVISIONS**

All implementations of revisions to this manual, except individual weight and balance data, should be entered in the record of revisions on the next page. Revisions must either be approved by the EASA or, in the case of documentary changes in accordance with Part 21A.263©(4), by the Design Organisation of AQUILA Aviation by Excellence AG.

Additions and revisions to the text in an existing section will be identified by a vertical black line adjacent to the applicable revised area. A new issue code appears in the footer of the pages of the revised section.

The operation of the AQUILA AT01 is only permitted with an Airplane Flight Manual in the current effective status carried on board.  
Please refer to our web page [www.aquila-aviation.de](http://www.aquila-aviation.de) whenever the revision status of your Airplane Flight Manual is in question.

| <b>Issue No.</b> | <b>Description of Revisions</b>                                 | <b>Revised Section(s)</b> | <b>Approval by AQUILA*/EASA Date/Signature</b> |
|------------------|---|---------------------------|--|
| A.01             | First Issue   | Alle                      | 30/08/2002                                     |
| A.02             | Installation of Garmin Avionic                                  | 0,2,9                     | 13/05/2003                                     |
| A.03             | Editorial corrections   | 0,4,5,7                   | 16/05/2003                                     |
| A.04             | Supplements for Bendix King equipment                           | 0,9                       | 09/07/2003                                     |
| A.05             | External Power, Supplement for Pointer ELT                      | 0,7,9                     | 09/10/2003                                     |
| A.06             | Winterization Kit   | 0,2,9                     | 10/03/2004                                     |
| A.07             | KANNAD 406 AF, ELT  | 0,9                       | 23/06/2005                                     |
| A.08             | Supplements for Garmin Avionic                                  | 0,1,4,9                   | 30/06/2005                                     |
| A.09             | Supplement for Bendix King KT 73                                | 0,9                       | 08/07/2005                                     |
| A.10             | Supplement for ARTEX ME406, ELT                                 | 0,9                       | 07/03/2008                                     |
| A.11             | Introduction of new Emergency Proc. And various AFM-Supplements | 0,3,9                     | 28/08/2008 (EASA)                              |

| <i>Dokument No.:</i> | <i>Issue:</i> | <i>Supersedes Issue:</i> | <i>Date:</i> | <i>Page:</i> |
|----------------------|---------------|--------------------------|--------------|--------------|
| FM-AT01-1010-100E    | A.18          | A.17 (07/10/2010)        | 29/11/2010   | 0 - 4        |

| <b>Issue No.</b> | <b>Description of Revisions</b>                      | <b>Revised Section(s)</b> | <b>Approval by AQUILA*/EASA Date/Signature</b> |
|------------------|--|---------------------------|--|
| A.12             | Documentary changes                                  | All                       | 28.11.2008                                     |
| A.13             | Supplement Garrecht Mode-S Transponder               | 0,9                       | 19/03/2009                                     |
| A.14             | Supplement for Day/Night-VFR-Operation               | 0,7,9                     | 03/09/09<br>(25.03.2010 EASA)                  |
| A.15             | Supplement ASPEN EFD 1000 PFD/MFD                    | 0,9                       | 07/12/2009                                     |
| A.16             | Supplement GARMIN G500-System                        | 0,9                       | 22.07.2010                                     |
| A.17             | Changes in supplement for GARMIN G500-sytem          | 0,9                       | 07.10.2010<br>(15.11.2010 EASA)                |
| A.18             | Normal procedure – Actions introduced by SB-AT01-020 | 0,4                       | 29.11.2010<br>(14.01.2011 EASA)                |

**APPROVAL\***

Issue A.18 of the Airplane Flight Manual is approved within the approval of Major-Change AT01-00438 Rev.A02 by EASA.

14. Jan. 2011  
Date

10033370  
EASA-approval

| <i>Dokument No.:</i> | <i>Issue:</i> | <i>Supersedes Issue:</i> | <i>Date:</i> | <i>Page:</i> |
|----------------------|---------------|--------------------------|--------------|--------------|
| FM-AT01-1010-100E    | A.18          | A.17 (07/10/2010)        | 29/11/2010   | 0 - 5        |

**RECORD OF REVISIONS**

When a new revision to the Airplane Flight Manual is issued, the corresponding sections have to be removed and replaced by the pages of the revised sections.

Only entire sections will be changed and have to be replaced. Each time, when the incorporation of a revision is accomplished, an endorsement has to be made in the record of revisions shown below.

| <b>Issue No.</b> | <b>Revised Sections</b> | <b>Date of Issue</b> | <b>Date of insertion:</b> | <b>Inserted by:</b> |
|------------------|-------------------------|----------------------|---------------------------|---------------------|
| A.01             | All                     | 05/06/2002           | ---                       | ---                 |
| A.02             | 0,2,9                   | 20/11/2002           |                           |                     |
| A.03             | 0,4,5,7                 | 15/04/2003           |                           |                     |
| A.04             | 0,9                     | 19/05/2003           |                           |                     |
| A.05             | 0,7,9                   | 30/09/2003           |                           |                     |
| A.06             | 0,2,9                   | 10/02/2004           |                           |                     |
| A.07             | 0,9                     | 30/07/2004           |                           |                     |
| A.08             | 0,1,4,9                 | 30/06/2005           |                           |                     |
| A.09             | 0,9                     | 05/07/2005           |                           |                     |
| A.10             | 0,9                     | 05/03/2006           |                           |                     |
| A.11             | 0,3,9                   | 30/11/2007           |                           |                     |
| A.12             | All                     | 17/09/2008           |                           |                     |
| A.13             | 0,9                     | 19/03/2009           |                           |                     |
| A.14             | 0,7,9                   | 03/09/2009           |                           |                     |
| A.15             | 0,9                     | 07/12/2009           |                           |                     |
| A.16             | 0,9                     | 22/7/2010            |                           |                     |
| A.17             | 0,9                     | 07/10/2010           |                           |                     |
| A.18             | 0,4                     | 29/11/2010           |                           |                     |

| <i>Dokument No.:</i> | <i>Issue:</i> | <i>Supersedes Issue:</i> | <i>Date:</i> | <i>Page:</i> |
|----------------------|---------------|--------------------------|--------------|--------------|
| FM-AT01-1010-100E    | A.18          | A.17 (07/10/2010)        | 29/11/2010   | 0 - 6        |

## Purchase of Technical Publications

To guarantee safe operation and correct maintenance of the aircraft AQUILA AT01, all manuals and technical publications must be kept in the current effective status.

All manuals and technical publications relating to the aircraft AQUILA AT01 are available from the companies listed below:

### (a) ***AQUILA AT01 related Manuals and Publications***

AQUILA Aviation by Excellence AG  
Flugplatz  
D-14959 SCHÖNHAGEN

Tel: +49 (0)33731 707-0  
Fax: +49 (0)33731 707-11  
E-Mail: kontakt@aquila-aviation.de  
Internet: <http://www.aquila-aviation.de>

### (b) ***Engine ROTAX 912 S related Manuals and Publications***

ROTAX<sup>®</sup> authorized distributor for ROTAX<sup>®</sup> Aircraft Engines of the applicable distribution area.

For contact details of the local authorized distributor for ROTAX Aircraft Engines, please refer to chapter 13 of the ROTAX<sup>®</sup> Operator's Manual for 912 S Engines.

### (c) ***Propeller MTV-21 related Manuals and Publications***

mt-Propeller Entwicklung GmbH  
Flugplatz Straubing- Wallmühle  
D-94348 ATTING

Tel: +49 (0)9429 9409-0  
Fax: +49 (0)9429 8432  
Internet: [www.mt-propeller.com](http://www.mt-propeller.com)  
E-mail: [sales@mt-propeller.com](mailto:sales@mt-propeller.com)

| <i>Dokument No.:</i> | <i>Issue:</i> | <i>Supersedes Issue:</i> | <i>Date:</i> | <i>Page:</i> |
|----------------------|---------------|--------------------------|--------------|--------------|
| FM-AT01-1010-100E    | A.18          | A.17 (07/10/2010)        | 29/11/2010   | 0 - 7        |



[Intentionally left blank]

| <i>Dokument No.:</i> | <i>Issue:</i> | <i>Supersedes Issue:</i> | <i>Date:</i> | <i>Page:</i> |
|----------------------|---------------|--------------------------|--------------|--------------|
| FM-AT01-1010-100E    | A.18          | A.17 (07/10/2010)        | 29/11/2010   | 0 - 8        |

## SECTION 1

### GENERAL

|       |   | Page |
|-------|---|------|
| 1.1   | INTRODUCTION                              | 1-2  |
| 1.2   | AIRCRAFT TYPE CERTIFICATION               | 1-2  |
| 1.3   | WARNING, CAUTIONS AND NOTES               | 1-3  |
| 1.4   | AIRCRAFT PRINCIPAL DIMENSIONS             | 1-4  |
| 1.4.1 | Overall Dimensions                        | 1-4  |
| 1.4.2 | Wings                                     | 1-4  |
| 1.4.3 | Horizontal Stabilizer / Elevator          | 1-4  |
| 1.4.4 | Fuselage and Vertical Stabilizer / Rudder | 1-4  |
| 1.4.5 | Landing Gear                              | 1-4  |
| 1.5   | AQUILA AT01 – THREE VIEW DRAWING          | 1-5  |
| 1.6   | ENGINE                                    | 1-6  |
| 1.7   | PROPELLER                                 | 1-6  |
| 1.8   | FUEL                                      | 1-6  |
| 1.9   | ENGINE OIL AND COOLANT                    | 1-7  |
| 1.9.1 | Engine Oil                                | 1-7  |
| 1.9.2 | Engine Coolant                            | 1-8  |
| 1.10  | WEIGHTS                                   | 1-8  |
| 1.11  | TERMINOLOGY AND ABBREVIATIONS             | 1-9  |
| 1.12  | CONVERSION FACTORS                        | 1-11 |

| <i>Dokument No.:</i> | <i>Issue:</i> | <i>Supersedes Issue:</i> | <i>Date:</i> | <i>Page:</i> |
|----------------------|---------------|--------------------------|--------------|--------------|
| FM-AT01-1010-100E    | A.12          | A.08 (30/06/2005)        | 17/09/2008   | 1 - 1        |



### 1.3 WARNING, CAUTIONS AND NOTES

Throughout the text, special text boxes termed as WARNING, CAUTION and NOTE are used to emphasize and address general remarks and special characteristics pertaining to aircraft handling as well as operation. These terms are defined as follows:

**WARNING**

Procedures, practices, etc. which may result in personal injury or loss of life if not thoroughly adhered to. The issues addressed under these text boxes directly affect the airworthiness and the safe operation of the airplane.

**CAUTION**

Procedures, practices, etc. which may result in damage to or destruction of equipment if not strictly adhered to. The issues addressed under these text boxes have an indirect or minor impact on the airworthiness and the safe operation of the airplane.

**NOTE**

Calls attention to additional procedures or information which are not directly associated with flight safety but nevertheless important or unusual to standard practices.

| <i>Dokument No.:</i> | <i>Issue:</i> | <i>Supersedes Issue:</i> | <i>Date:</i> | <i>Page:</i> |
|----------------------|---------------|--------------------------|--------------|--------------|
| FM-AT01-1010-100E    | A.12          | A.08 (30/06/2005)        | 17/09/2008   | 1 - 3        |

## 1.4 AIRCRAFT PRINCIPAL DIMENSIONS

### 1.4.1 Overall Dimensions

|            |      |   |
|------------|------|---|
| Wing Span: | 10.3 | m |
| Length:    | 7.35 | m |
| Height:    | 2.4  | m |

### 1.4.2 Wings

|                                  |            |                |
|----------------------------------|------------|----------------|
| Airfoil:                         | HQ-XX mod. |                |
| Area:                            | 10.5       | m <sup>2</sup> |
| Aspect Ratio:                    | 10.1       |                |
| Mean Aerodynamic<br>Chord (MAC): | 1.07       | m              |

### 1.4.3 Horizontal Stabilizer / Elevator

|       |     |                |
|-------|-----|----------------|
| Area: | 2.0 | m <sup>2</sup> |
| Span: | 3.0 | m              |

### 1.4.4 Fuselage and Vertical Stabilizer / Rudder

|            |      |   |
|------------|------|---|
| Max. Width | 1.20 | m |
| Length     | 7.35 | m |

### 1.4.5 Landing Gear

|               |        |                             |
|---------------|--------|-----------------------------|
| Wheel Track:  | 1.938  | m                           |
| Wheel Base:   | 1.685  | m                           |
| Tire Sizes    |        |                             |
| Nose Gear:    | 5.00-5 | (Cleveland Wheels & Brakes) |
| Main Gear:    | 5.00-5 | (Cleveland Wheels & Brakes) |
| Tire Pressure |        |                             |
| Nose Gear:    | 2.0    | bar                         |
| Main Gear:    | 2.5    | bar                         |

|                      |               |                          |              |              |
|----------------------|---------------|--------------------------|--------------|--------------|
| <i>Dokument No.:</i> | <i>Issue:</i> | <i>Supersedes Issue:</i> | <i>Date:</i> | <i>Page:</i> |
| FM-AT01-1010-100E    | A.12          | A.08 (30/06/2005)        | 17/09/2008   | 1 - 4        |

**1.5 AQUILA AT01 – Three View Drawing**

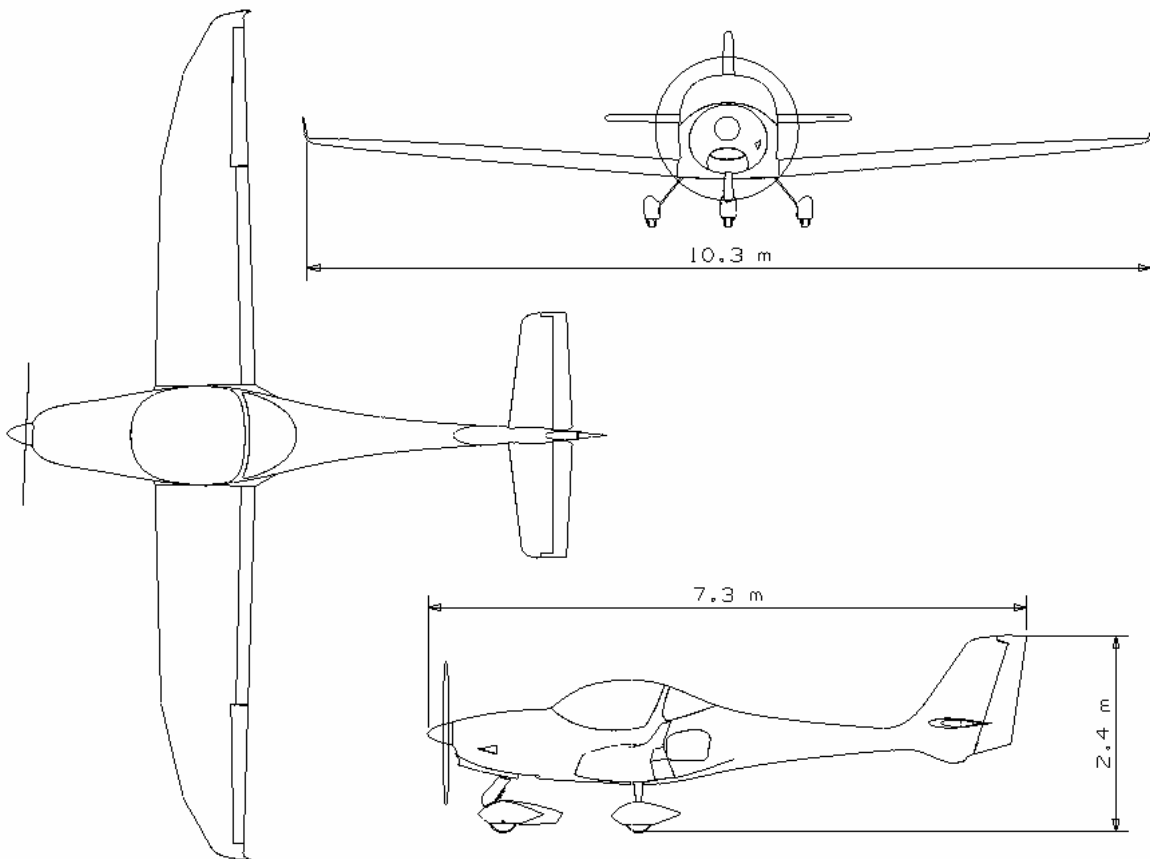

| <i>Dokument No.:</i> | <i>Issue:</i> | <i>Supersedes Issue:</i> | <i>Date:</i> | <i>Page:</i> |
|----------------------|---------------|--------------------------|--------------|--------------|
| FM-AT01-1010-100E    | A.12          | A.08 (30/06/2005)        | 17/09/2008   | 1 - 5        |

## 1.6 ENGINE

The ROTAX® 912 S3 is a 4-cylinder 4-stroke engine with ram air cooled and horizontally opposed cylinders as well as liquid cooled cylinder heads. The Propeller is driven via an internal reduction gearbox with an integrated overload clutch and a hydraulic constant speed propeller governor.

|                                      |          |                 |
|--------------------------------------|----------|-----------------|
| Reduction Ratio of internal gearbox: | 2.43 : 1 |                 |
| Displacement:                        | 1352     | cm <sup>3</sup> |
| Take-Off Performance:                | 69.0     | kW              |
| at a Propeller Shaft Speed of        | 2263     | 1/min           |

## 1.7 PROPELLER

Two-blade, constant speed propeller manufactured by mt-Propeller Entwicklung GmbH.

|  |                 |
|--|-----------------|
| Type:  | MTV-21-A/175-05 |
| Hydraulically Controlled Variable Pitch (Constant Speed) Propeller |                 |
| Max. Propeller Diameter:   | 175 cm          |

## 1.8 FUEL

The following fuel grades are approved for usage (min. RON 95):

|                    |
|--------------------|
| EN228 Premium      |
| EN228 Premium plus |
| AVGAS 100LL        |

|                        | <u>Left Fuel Tank</u> | <u>Right Fuel Tank</u> |
|------------------------|-----------------------|------------------------|
| Fuel Capacity (total): | 60                    | 60 Litres              |
| Usable Fuel (total) :  | 54.8                  | 54.8 Litres            |
| Unusable Fuel:         | 5.2                   | 5.2 Litres             |

Due to the higher lead content in AVGAS, the wear of the valve seats, the deposits in the combustion chamber and lead sediments in the lubrication system will increase when using this type of fuel. Therefore, use AVGAS only if you encounter problems with vapour lock or if the other fuel types are not available (refer also to the Operators Manual for ROTAX® Engine Type 912 Series, latest revision).

| <i>Dokument No.:</i> | <i>Issue:</i> | <i>Supersedes Issue:</i> | <i>Date:</i> | <i>Page:</i> |
|----------------------|---------------|--------------------------|--------------|--------------|
| FM-AT01-1010-100E    | A.12          | A.08 (30/06/2005)        | 17/09/2008   | 1 - 6        |

## 1.9 ENGINE OIL AND COOLANT

### 1.9.1 Engine Oil

Use only oil with API classification "SG" or higher.

Heavy duty 4-stroke motor cycle oils meet normally all the requirements.

For more information regarding engine oil selection, refer to the Operator's Manual for all versions of 912 series engines, section 10.2.3, and to ROTAX® Service Instruction SI-912-016, latest revision.

The following chart shows the recommended oil viscosity as a function of the climatic conditions. The use of multi-grade oils is recommended.

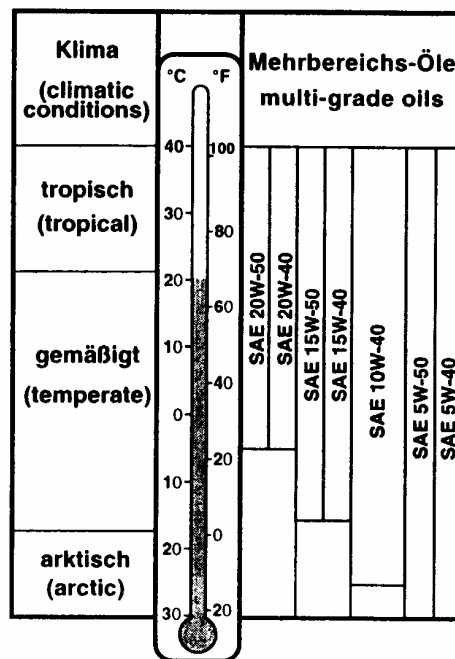

Figure 1-2

**CAUTION**

Do not use aviation grade oil !

When operating the engine with AVGAS do not use full synthetic oil types!

When operating the engine with AVGAS, more frequent oil changes will be required!  
(refer also to ROTAX® Service Instruction SI-912-016, latest rev., for more information)

Max. Oil Capacity : 3.0 Litres  
Quantity between Max/Min 0.45 Litres  
Max. Oil Consumption: 0.06 Litres/h

| Dokument No.:     | Issue: | Supersedes Issue: | Date:      | Page: |
|-------------------|--------|-------------------|------------|-------|
| FM-AT01-1010-100E | A.12   | A.08 (30/06/2005) | 17/09/2008 | 1 - 7 |



### 1.9.2 Engine Coolant

Only the following water-free coolant concentrate based on propylene glycol is approved for the usage in the AQUILA AT01.

| Designation | Mixture Ratio % |       |
|-------------|-----------------|-------|
|             | Concentrate     | Water |
| EVANS NPG+® | 100             | 0     |

When correctly applied (100% coolant concentration), there is sufficient protection against vapour bubble formation, freezing or thickening of the coolant within the operating limits.

|                |
|----------------|
| <b>WARNING</b> |
|----------------|

The coolant concentrate EVANS NPG+® must not be mixed with conventional glycol/water coolant or with additives. The disregarding of this warning can lead to damages to the cooling system and, as a result, to motor damages, since the properties of the coolant do not longer exist (refer also to ROTAX® SB-912-043, latest revision, as well as ROTAX Service Instruction SI-912-016, latest revision, for more information).

|                |
|----------------|
| <b>CAUTION</b> |
|----------------|

Qualitatively inferior and contaminated coolant may lead to deposits in the cooling system which may result in an insufficient engine cooling.

**Coolant Quantity Total:** Minimum: 2.4 Litres  
Maximum: 2.5 Litres

**Coolant Quantity in the Overflow Bottle:** Minimum: 0.1 Litres  
Maximum: 0.2 Litres

### 1.10 WEIGHTS

Max. Takeoff Weight (MTOW): 750 kg  
 Max. Landing Weight (MLW): 750 kg  
 Empty Weight: Refer to section 6  
 Max. Weight in Baggage Compartment: 40 kg  
 (All baggage must be adequately strapped and secured)  
 Max. Wing Loading: 71.4 kg/m<sup>2</sup>  
 Min. Wing Loading: circa 52.6 kg/m<sup>2</sup>

| <i>Dokument No.:</i> | <i>Issue:</i> | <i>Supersedes Issue:</i> | <i>Date:</i> | <i>Page:</i> |
|----------------------|---------------|--------------------------|--------------|--------------|
| FM-AT01-1010-100E    | A.12          | A.08 (30/06/2005)        | 17/09/2008   | 1 - 8        |

## 1.11 TERMINOLOGY AND ABBREVIATIONS

### 1.11.1 Airspeeds

**IAS:** (Indicated Airspeed), Speed as shown on the airspeed indicator.

**KIAS:** IAS expressed in Knots

**CAS:** (Calibrated Airspeed), Means the indicated airspeed, corrected for position and instrument error. CAS is equal to true airspeed in standard atmosphere conditions at sea level.

**KCAS:** CAS expressed in Knots

**TAS:** (True Airspeed), Airspeed relative to undisturbed air, which is the CAS corrected for altitude, temperature and compressibility.

**GS:** (Ground speed), Airspeed relative to ground.

**$V_A$ :** Manoeuvring Speed

**$V_S$ :** Stalling speed without engine power.

**$V_{S0}$ :** Stalling speed without engine power in the landing configuration.

**$V_X$ :** Best Angle-of-Climb Speed

**$V_Y$ :** Best Rate-of-Climb Speed

**$V_{FE}$ :** Maximum Flap Extended Speed

**$V_{NE}$ :** Never Exceed Speed - The speed limit that must not be exceeded at any time.

**$V_{NO}$ :** Maximum Structural Cruising Speed is the speed that should not be exceeded except in smooth air and then only with caution.

### 1.11.2 Weight and Balance

**Reference Datum** An imaginary vertical plane from which all horizontal distances are measured for balance purposes.

**Reference line** fixed horizontal reference line

| <i>Dokument No.:</i> | <i>Issue:</i> | <i>Supersedes Issue:</i> | <i>Date:</i> | <i>Page:</i> |
|----------------------|---------------|--------------------------|--------------|--------------|
| FM-AT01-1010-100E    | A.12          | A.08 (30/06/2005)        | 17/09/2008   | 1 - 9        |

|                                  |   |
|----------------------------------|---|
| <i>Lever Arm:</i>                | The horizontal distance from the reference datum to the centre of gravity (C.G.) of an item.                          |
| <i>Moment:</i>                   | The product of the weight of an item multiplied by its lever arm.   |
| <i>Empty Weight:</i>             | Weight of the aircraft including unusable fuel, full operating liquids and full oil.                                  |
| <i>Max. Takeoff Weight:</i>      | Maximum permissible weight approved for the conduction of the takeoff run.  |
| <i>Useful Load:</i>              | Difference between takeoff weight and basic empty weight.   |
| <i>Usable Fuel</i> :             | Fuel available for flight planning.   |
| <i>Unusable Fuel:</i>            | Fuel remaining in the fuel tanks that cannot be safely used in flight.  |
| <i>Centre of Gravity (C.G.):</i> | The point at which an aircraft would be in the balanced condition if seated/suspended on that point (centre of mass). |
| <i>MAC:</i>                      | Mean aerodynamic chord  |

### 1.11.3 Meteorological Terminology

|                 |  |
|-----------------|--|
| <i>OAT:</i>     | Outside Air Temperature                        |
| <i>VFR, day</i> | day: (SR) Sunrise-30 min to (SS) Sunset+30 min |

### 1.11.4 Engine and Performance

|                               |   |
|-------------------------------|---|
| <i>Takeoff Power:</i>         | Maximum power permissible for takeoff.            |
| <i>Max. Continuous Power:</i> | Maximum power permitted for continuous operation. |

### 1.11.5 Miscellaneous

|                          |                                 |
|--------------------------|---------------------------------|
| <i>Serial No. (S/N):</i> | Serial Number of the Aircraft   |
| <i>Part No. (P/N):</i>   | Part Number                     |
| <i>GFRP:</i>             | Glass Fibre Reinforced Plastic  |
| <i>CFRP:</i>             | Carbon Fibre Reinforced Plastic |
| <i>ACL:</i>              | Anti Collision Light            |

| <i>Dokument No.:</i> | <i>Issue:</i> | <i>Supersedes Issue:</i> | <i>Date:</i> | <i>Page:</i> |
|----------------------|---------------|--------------------------|--------------|--------------|
| FM-AT01-1010-100E    | A.12          | A.08 (30/06/2005)        | 17/09/2008   | 1 - 10       |

## 1.12 CONVERSION FACTORS

### 1.12.1 Length

|      |   |       |    |
|------|---|-------|----|
| 1 ft | = | 0.304 | m  |
| 1 in | = | 25.4  | mm |

### 1.12.2 Airspeed

|       |   |       |      |
|-------|---|-------|------|
| 1 kts | = | 1.852 | km/h |
| 1 mph | = | 1.609 | km/h |

### 1.12.3 Pressure

|         |   |        |                  |   |        |
|---------|---|--------|------------------|---|--------|
| 1 hPa   | = | 100    | N/m <sup>2</sup> | = | 1 mbar |
| 1 in Hg | = | 33.865 | hPa              |   |        |
| 1 psi   | = | 68.97  | mbar             |   |        |

### 1.12.4 Mass ("Weight")

|       |   |       |    |
|-------|---|-------|----|
| 1 lbs | = | 0.454 | kg |
|-------|---|-------|----|

### 1.12.5 Volume

|                   |   |       |       |
|-------------------|---|-------|-------|
| 1 US Gallon       | = | 3.78  | Litre |
| 1 Imperial Gallon | = | 4.546 | Litre |

### 1.12.6 Temperature

|                     |   |                   |
|---------------------|---|-------------------|
| (t) °C (Celsius)    | = | 5/9 ((t) °F - 32) |
| (t) °F (Fahrenheit) | = | 9/5 (t) °C + 32   |

|                      |               |                          |              |              |
|----------------------|---------------|--------------------------|--------------|--------------|
| <i>Dokument No.:</i> | <i>Issue:</i> | <i>Supersedes Issue:</i> | <i>Date:</i> | <i>Page:</i> |
| FM-AT01-1010-100E    | A.12          | A.08 (30/06/2005)        | 17/09/2008   | 1 - 11       |

**1.12.7      RESERVED**

**[Intentionally left blank]**

| <i>Dokument No.:</i> | <i>Issue:</i> | <i>Supersedes Issue:</i> | <i>Date:</i> | <i>Page:</i> |
|----------------------|---------------|--------------------------|--------------|--------------|
| FM-AT01-1010-100E    | A.12          | A.08 (30/06/2005)        | 17/09/2008   | 1 - 12       |

**SECTION 2  
LIMITATIONS**

|      |   | Page |
|------|---|------|
| 2.1  | INTRODUCTION                                  | 2-2  |
| 2.2  | AIRSPPEED LIMITATIONS                         | 2-2  |
| 2.3  | AIRSPPEED INDICATOR MARKINGS                  | 2-3  |
| 2.4  | POWER PLANT LIMITATIONS                       | 2-3  |
| 2.5  | POWER PLANT INSTRUMENT MARKINGS               | 2-5  |
| 2.6  | OTHER INSTRUMENT MARKINGS                     | 2-6  |
| 2.7  | MASS LIMITS (Weight Limits)                   | 2-6  |
| 2.8  | CENTER OF GRAVITY LIMITS                      | 2-6  |
| 2.9  | MANOEUVRE LIMITS                              | 2-7  |
| 2.10 | FLIGHT LOAD FACTORS                           | 2-7  |
| 2.11 | CREW  | 2-8  |
| 2.12 | KINDS OF OPERATION LIMITS / MINIMUM EQUIPMENT | 2-8  |
| 2.13 | FUEL LIMITATIONS                              | 2-9  |
| 2.14 | DEMONSTRATED CROSSWIND COMPONENT              | 2-9  |
| 2.15 | TEMPERATURE LIMITATIONS                       | 2-9  |
| 2.16 | PLACARDS                                      | 2-10 |
| 2.17 | RESERVED                                      | 2-20 |

| <i>Document No.:</i> | <i>Issue:</i> | <i>Supersedes Issue:</i> | <i>Date:</i> | <i>Page:</i> |
|----------------------|---------------|--------------------------|--------------|--------------|
| FM-AT01-1010-100E    | A.12          | A.06 (10/02/2004)        | 17/09/2008   | 2 - 1        |

## 2.1 INTRODUCTION

This section includes all operating limitations, instrument markings, and basic placards necessary for the safe operation of the aircraft, its engine, standard systems and standard equipment.

|                |
|----------------|
| <b>WARNING</b> |
|----------------|

The aircraft must be operated in compliance with the operating limitations.

## 2.2 AIRSPEED LIMITATIONS

The airspeeds given below are expressed in knots Indicated Airspeeds (IAS):

| Indicated Airspeed (IAS)                                   | [kts]      | Remarks  |
|--|------------|--|
| <b>V<sub>A</sub></b><br>Manoeuvring Speed                  | <b>112</b> | Do not make full or abrupt control movements above this speed.<br>This may result in overloading the aircraft structure. |
| <b>V<sub>FE</sub></b><br>Maximum Flap Extended Speed       | <b>90</b>  | Do not exceed this speed with flaps extended.  |
| <b>V<sub>NO</sub></b><br>Maximum Structural Cruising Speed | <b>130</b> | Do not exceed this Speed except in smooth air, and then only with caution.   |
| <b>V<sub>NE</sub></b><br>Never Exceed Speed                | <b>165</b> | Do not exceed this speed in any operational condition.   |

|                      |               |                          |              |              |
|----------------------|---------------|--------------------------|--------------|--------------|
| <i>Document No.:</i> | <i>Issue:</i> | <i>Supersedes Issue:</i> | <i>Date:</i> | <i>Page:</i> |
| FM-AT01-1010-100E    | A.12          | A.06 (10/02/2004)        | 17/09/2008   | 2 - 2        |

## 2.3 AIRSPEED INDICATOR MARKINGS

The airspeeds given below are expressed in knots Indicated Airspeeds (IAS):

| Marking (IAS) | [kts]          | Remarks  |
|---------------|----------------|--|
| White Arc     | <b>44-90</b>   | Full Flap Operating Range  |
| Green Arc     | <b>52-130</b>  | Normal Operating Range   |
| Yellow Arc    | <b>130-165</b> | Operations in this region must be conducted with caution and are allowed only in smooth air. |
| Red Line      | <b>165</b>     | Maximum speed for all operations.  |

## 2.4 POWER PLANT LIMITATIONS

### 2.4.1 Engine

- a) Manufacturer: BRP-ROTAX GmbH & Co KG, Gunskirchen, Austria
- b) Model: 912 S3

|             |
|-------------|
| <b>NOTE</b> |
|-------------|

The engine is equipped with a hydraulic propeller governor and drives the propeller via a reduction gearbox. The gearbox reduction ratio is 2.43 : 1.

The Tachometer indicates the propeller speed. As a result all RPM readings in this Manual are expressed as propeller speeds, unlike the data in the Engine Operator's Manual.

- c) Power Plant Limitations

Maximum Takeoff Power: 69.0 kW  
Maximum Takeoff Propeller Speed: 2260 rpm

| Document No.:     | Issue: | Supersedes Issue: | Date:      | Page: |
|-------------------|--------|-------------------|------------|-------|
| FM-AT01-1010-100E | A.12   | A.06 (10/02/2004) | 17/09/2008 | 2 - 3 |



Maximum Continuous Power: 69.0 kW  
Maximum Continuous Propeller Speed: 2260 rpm

d) Oil Pressure

Minimum: 0.8 bar below 1440 rpm  
Normal: 2.0 – 5.0 bar above 1440 rpm

Maximum during Cold Start:  
(for a short period of time) 7.0 bar

e) Fuel Pressure

Minimum: Red Warning Light

f) Oil Temperature

Maximum: 130 °C  
Minimum: 50 °C

Optimal Operating Temperature: 90 – 110 °C

g) Cylinder Head Temperature

Maximum: 135 °C

### 2.4.2 Propeller

a) Manufacturer: MT-Propeller Entwicklung GmbH, Atting, Germany

b) Model: MTV-21-A/175-05

c) Propeller Diameter: 1.75 m

d) Propeller Speed Limitations

Maximum Takeoff Propeller Speed: 2260 rpm  
Maximum Continuous Propeller Speed: 2260 rpm

| <i>Document No.:</i> | <i>Issue:</i> | <i>Supersedes Issue:</i> | <i>Date:</i> | <i>Page:</i> |
|----------------------|---------------|--------------------------|--------------|--------------|
| FM-AT01-1010-100E    | A.12          | A.06 (10/02/2004)        | 17/09/2008   | 2 - 4        |

## 2.5 POWER PLANT INSTRUMENT MARKINGS

The following table shows the power plant instrument markings and their colour code significance.

| <b>Instrument ⇒</b>                             | <b>Tachometer<br/>[rpm]</b> | <b>Oil<br/>Temperature<br/>[°C]</b> | <b>Cylinder Head<br/>temperature<br/>[°C]</b> | <b>Oil Pressure<br/>[bar]</b> |
|---|-----------------------------|-------------------------------------|---|-------------------------------|
| <b>Red Line</b><br>(Minimum)                    | ---                         | 50                                  | ---   | 0.8                           |
| <b>Green Arc</b><br>(Normal Operating<br>Range) | 535-2260                    | 50-130                              | ---   | 2.0 – 5.0                     |
| <b>Yellow Arc</b><br>(Caution)                  | ---                         | ---                                 | ---   | 0.8 – 2.0<br>5.0 – 7.0        |
| <b>Red Line</b><br>(Maximum)                    | 2260                        | 130                                 | 135   | 7.0                           |

| <i>Document No.:</i> | <i>Issue:</i> | <i>Supersedes Issue:</i> | <i>Date:</i> | <i>Page:</i> |
|----------------------|---------------|--------------------------|--------------|--------------|
| FM-AT01-1010-100E    | A.12          | A.06 (10/02/2004)        | 17/09/2008   | 2 - 5        |

## 2.6 OTHER INSTRUMENT MARKINGS

| Instrument       | Red Arc<br>(Minimum) | Green Arc<br>(Normal Operat.<br>Range) | Green/Red Arc<br>(Caution) | Red Arc<br>(Maximum) |
|------------------|----------------------|--|----------------------------|----------------------|
| Voltmeter<br>[V] | 8 – 11               | 12 – 15                                | 11 – 12                    | 15 – 16              |
| Ammeter<br>[A]   | ---                  | ---                                    | ---                        | ---                  |

## 2.7 MASS LIMITS (Weight Limits)

|                                  |     |    |
|----------------------------------|-----|----|
| Maximum Takeoff Mass             | 750 | kg |
| Maximum Landing Mass             | 750 | kg |
| Max. Mass in Baggage Compartment | 40  | kg |

|                |
|----------------|
| <b>WARNING</b> |
|----------------|

Exceeding the weight limits may result in overloading the aircraft and a significant deterioration of its flight performance and handling qualities.

## 2.8 CENTER OF GRAVITY LIMITS

The detailed procedure for the determination of the basic empty weight of the aircraft and the centre of gravity location is provided in section 6 of this manual.

The reference datum is located at the wing leading edge, at the fuselage-wing intersection. With the aircraft horizontally levelled out, the reference datum and the vertical (perpendicular) are in one plane.

The centre of gravity must be within the following limits:

|                |               |                 |
|----------------|---------------|-----------------|
| Forward Limit  | 31% MAC = 427 | mm aft of Datum |
| Rearward Limit | 40% MAC = 523 | mm aft of Datum |

| <i>Document No.:</i> | <i>Issue:</i> | <i>Supersedes Issue:</i> | <i>Date:</i> | <i>Page:</i> |
|----------------------|---------------|--------------------------|--------------|--------------|
| FM-AT01-1010-100E    | A.12          | A.06 (10/02/2004)        | 17/09/2008   | 2 - 6        |

**WARNING**

The aircraft may only be operated with a centre of gravity position within the approved operating range, otherwise, the controllability and/or longitudinal stability of the aircraft as well as its overall handling qualities will be significantly reduced. The procedure to determine the centre of gravity location for flight is provided in Section 6 of this handbook.

## 2.9 MANOEUVRE LIMITS

The aircraft is type-certificated in accordance with the JAR-VLA. That certification includes the following manoeuvres:

- a) All normal, non acrobatic manoeuvres.
- b) Stalls: Static stalls with slow deceleration
- c) Steep Turns: Bank Angle < 60°
- d) Chandelle: Entry Speed 120 kts
- e) Lazy Eight: Entry Speed 110 kts

**NOTE**

All acrobatic manoeuvres as well as manoeuvres with bank angles exceeding 60° are prohibited.

## 2.10 FLIGHT LOAD FACTORS

The following flight load factor limits must be kept while performing permissible manoeuvres.

| Flight Load Factor [g] | with V <sub>A</sub> | with V <sub>NE</sub> | With Flaps Extended |
|------------------------|---------------------|----------------------|---------------------|
| <b>Positive</b>        | 4.0                 | 4.0                  | 2.0                 |
| <b>Negative</b>        | -2.0                | -2.0                 | 0                   |

**WARNING**

Exceeding the flight load factor limits may result in damage of the aircraft structure.

| <i>Document No.:</i> | <i>Issue:</i> | <i>Supersedes Issue:</i> | <i>Date:</i> | <i>Page:</i> |
|----------------------|---------------|--------------------------|--------------|--------------|
| FM-AT01-1010-100E    | A.12          | A.06 (10/02/2004)        | 17/09/2008   | 2 - 7        |

|                |
|----------------|
| <b>CAUTION</b> |
|----------------|

Manoeuvres that include negative flight load factors are not permitted.  
Intentional Spinning is not permitted.

## 2.11 CREW

Maximum Persons on Board: 2

Minimum Crew: 1 Pilot  
With only one person on board, the aircraft may only be operated from the left seat.

## 2.12 KINDS OF OPERATION LIMITS / MINIMUM EQUIPMENT

The aircraft may only be operated under DAY-VFR conditions.

Minimum Equipment: Flight- and Navigation Instruments

|                    |                  |
|--------------------|------------------|
| Altimeter          | (0 to 20,000 ft) |
| Airspeed Indicator | (0 to 200 kts)   |
| Magnetic Compass   |                  |

Minimum Equipment: Power Plant Instruments

|                                 |                             |
|---------------------------------|-----------------------------|
| Fuel Level Indicator            | Oil Temperature Indicator   |
| Low Fuel Pressure Warning Light | Oil Pressure Indicator      |
| Cyl. Head Temperature Indicator | Manifold Pressure Indicator |
| Ammeter                         | Tachometer                  |
| Voltmeter                       | Warning Light "Alternator"  |

Minimum Equipment: Cabin

2 x Safety Belts

|             |
|-------------|
| <b>NOTE</b> |
|-------------|

For specific operational conditions, additional equipment may be required.  
It is the aircraft operator's responsibility to observe the applicable national operational requirements.

| <i>Document No.:</i> | <i>Issue:</i> | <i>Supersedes Issue:</i> | <i>Date:</i> | <i>Page:</i> |
|----------------------|---------------|--------------------------|--------------|--------------|
| FM-AT01-1010-100E    | A.12          | A.06 (10/02/2004)        | 17/09/2008   | 2 - 8        |

## 2.13 FUEL LIMITATIONS

|                        | <u>Left Fuel Tank</u> | <u>Right Fuel Tank</u> |        |
|------------------------|-----------------------|------------------------|--------|
| Fuel Capacity (total): | 60                    | 60                     | Litres |
| Usable Fuel (total) :  | 54.8                  | 54.8                   | Litres |
| Unusable Fuel:         | 5.2                   | 5.2                    | Litres |

For approved fuel grades, refer to paragraph 1.8.

## 2.14 DEMONSTRATED CROSSWIND COMPONENT

The maximum demonstrated crosswind component is 15.0 kts / 27.0 km/h.

|                |
|----------------|
| <b>WARNING</b> |
|----------------|

A takeoff with crosswind components outside of this limit may result in the loss of aircraft controllability.

## 2.15 TEMPERATURE LIMITATIONS

Temperature range for aircraft operation:

|   |        |                         |
|---|--------|-------------------------|
| Minimum Temperature for Takeoff:                                    | -25 °C | Outside Air Temperature |
| Maximum Temperature for Takeoff:                                    | 38 °C  | Outside Air Temperature |
| Maximum Temperature for Takeoff<br>with installed Winterization Kit | 15 °C  | Outside Air Temperature |

Those parts of the aeroplane's structure which are exposed to direct vertical sunlight have to be coloured WHITE.

| <i>Document No.:</i> | <i>Issue:</i> | <i>Supersedes Issue:</i> | <i>Date:</i> | <i>Page:</i> |
|----------------------|---------------|--------------------------|--------------|--------------|
| FM-AT01-1010-100E    | A.12          | A.06 (10/02/2004)        | 17/09/2008   | 2 - 9        |

## 2.16 PLACARDS

- 1.) In the lower mid section of the instrument panel:

The aircraft is certified for VFR flights on day, outside of icing conditions. No aerobatic maneuvers, including spins are approved. For further operating limitations refer to POH.

- 2.) On the instrument panel, below the airspeed indicator:

Maneuvering Speed  
V<sub>A</sub> = 112 kts

- 3.) In the lower left section of the instrument panel, below the switches:

**ALT / BAT**

Fuel  
Pump

Avionics

Nav-  
Lights

ACL

Landing  
Lights

Instrument  
Light

Cabin  
Light

- 4.) On the instrument panel, adjacent to the flap switch (the coloured strips are located on the upper surface of the left flap as a visual flap position indicator):

**CRUISE**



(RED – marks Cruise Position (Flaps 0°))

**T/O**



(YELLOW – marks Take-off Position (Flaps 17°))

**Landing**



(GREEN – marks Landing Position (Flaps 35°))

| <i>Document No.:</i> | <i>Issue:</i> | <i>Supersedes Issue:</i> | <i>Date:</i> | <i>Page:</i> |
|----------------------|---------------|--------------------------|--------------|--------------|
| FM-AT01-1010-100E    | A.12          | A.06 (10/02/2004)        | 17/09/2008   | 2 - 10       |

5.) On the instrument panel, adjacent to the right side of the circuit breakers:

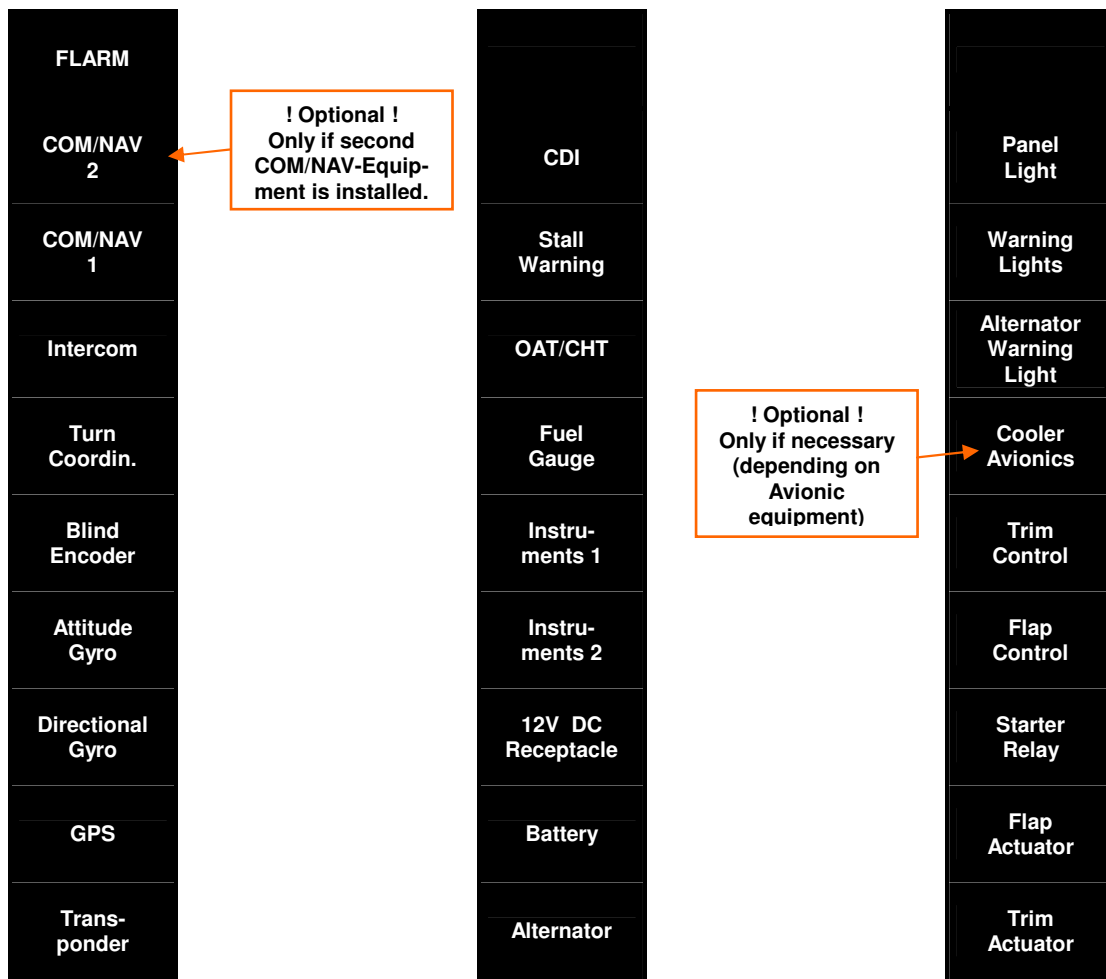

**NOTE**

Depending on the equipment installed in the aircraft, not every position shown above might be actually assigned with a circuit breaker. In those cases the respective positions are covered by a blank plastic plug and reserved for that application by the placard. Furthermore, the positioning of the circuit breakers can vary on early aircraft serial numbers and diverge from the arrangement shown above. In some cases, the circuit breaker for the CDI may be placed together with its correct marking on the GPS or COM/NAV 2 position of the above illustration.

6.) On the instrument panel (left section) near the magnetic compass:

|       |   |               |     |   |     |     |
|-------|---|---------------|-----|---|-----|-----|
| FOR   | N | 30            | 60  | E | 120 | 150 |
| STEER |   |               |     |   |     |     |
| FOR   | S | 210           | 240 | W | 300 | 330 |
| STEER |   |               |     |   |     |     |
| DATE: |   | AIRPATH C2300 |     |   |     |     |

|                      |               |                          |              |              |
|----------------------|---------------|--------------------------|--------------|--------------|
| <i>Document No.:</i> | <i>Issue:</i> | <i>Supersedes Issue:</i> | <i>Date:</i> | <i>Page:</i> |
| FM-AT01-1010-100E    | A.12          | A.06 (10/02/2004)        | 17/09/2008   | 2 - 11       |



- 7.) On the instrument panel, adjacent to the right side of the trim position indicator:

**TRIM  
CONTROL****NOSE DOWN****T/O****NOSE UP**

- 8.) In the left section of the instrument panel, adjacent to the airspeed indicator:

**NO  
SMOKING**

- 9.) On the instrument panel, below the fuel level indicator:

**FUEL CAPACITY  
109,6 Liter Usable**

- 10.) On the instrument panel, below the oil pressure indicator:

**OIL PRESS.**

- 11.) On the instrument panel, below the oil temperature indicator:

**OIL TEMP.**

- 12.) On the instrument panel, below the cylinder head temperature indicator:

**CYL. HEAD TEMP.**

| <i>Document No.:</i> | <i>Issue:</i> | <i>Supersedes Issue:</i> | <i>Date:</i> | <i>Page:</i> |
|----------------------|---------------|--------------------------|--------------|--------------|
| FM-AT01-1010-100E    | A.12          | A.06 (10/02/2004)        | 17/09/2008   | 2 - 12       |

13.) On the instrument panel, below the voltmeter:

**Voltmeter**

14.) On the instrument panel, below the amperemeter:

**Ammeter**

15.) On the control panel below the midsection of the instrument panel adjacent to the corresponding control element:

**CABIN HEAT  
PULL ON**

**CARB. HEAT  
PULL ON**

**CHOKE  
PULL ON**

16.) On the centre pedestal, in front and behind the throttle and propeller control levers:

**OPEN**

**HIGH  
RPM**

**IDLE**

**LOW  
RPM**

17.) On the centre pedestal adjacent to the trim control switch:

**NOSE DOWN**

**Trim  
Switch**

**TRIM  
SWITCH**

**NOSE UP**

| <i>Document No.:</i> | <i>Issue:</i> | <i>Supersedes Issue:</i> | <i>Date:</i> | <i>Page:</i> |
|----------------------|---------------|--------------------------|--------------|--------------|
| FM-AT01-1010-100E    | A.12          | A.06 (10/02/2004)        | 17/09/2008   | 2 - 13       |

18.) On the centre pedestal below the fuel selector/shut-off valve:

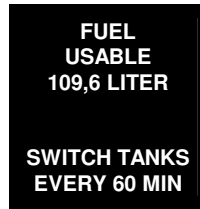

19.) On the centre pedestal below the parking brake control lever:

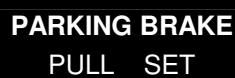

20.) On the inner as well as the outer side of the left canopy frame in front and behind the canopy release handle:

a) Left side of each canopy release handle:

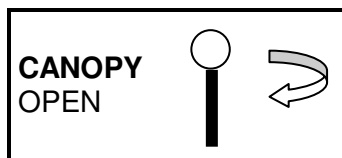

b) Right side of each canopy release handle:

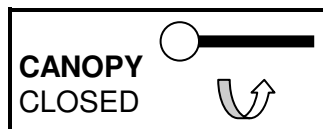

21.) On the centre pedestal between the seats:

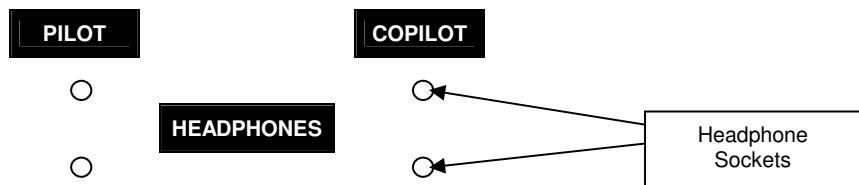

| <i>Document No.:</i> | <i>Issue:</i> | <i>Supersedes Issue:</i> | <i>Date:</i> | <i>Page:</i> |
|----------------------|---------------|--------------------------|--------------|--------------|
| FM-AT01-1010-100E    | A.12          | A.06 (10/02/2004)        | 17/09/2008   | 2 - 14       |

22.) On the inner surface of the baggage compartment door:

**BAGGAGE MAX: 40 kg  
SECURELY  
ANCHOR DOWN**

23.) On the brake fluid reservoir at the firewall in the engine compartment:

**HYD. BRAKE  
FLUID (FLUID 4)**

24.) On the inner surface of the service opening in the upper engine cowling:

**! CAUTION !  
DO NOT use aviation grade oil  
Refer to POH**

25.) On the oil filler cap (oil tank cover):

**OIL CAPACITY 3,0 (l)  
REFER to POH**

26.) On the engine coolant overflow bottle:

**COOLANT**

27.) On the engine coolant expansion tank:

**COOLANT  
DO NOT OPEN**

| <i>Document No.:</i> | <i>Issue:</i> | <i>Supersedes Issue:</i> | <i>Date:</i> | <i>Page:</i> |
|----------------------|---------------|--------------------------|--------------|--------------|
| FM-AT01-1010-100E    | A.12          | A.06 (10/02/2004)        | 17/09/2008   | 2 - 15       |

- 28.) On both wings, forward of the fuel filler caps (relating to flight direction):

**EN 228 SUPER  
EN 228 SUPER plus  
AVGAS 100 LL  
  
USABLE 54,8 Liter**

- 29.) On the outer surface of the fuselage at the position of the ELT (if installed)

**ELT**  
INSTALLED HERE

- 30.) Adjacent to the fuel drain valves on the lower surface of both wings and the front fuselage (located on 3 positions):

**FUEL DRAIN**

- 31.) Adjacent to the tie-down points under both wings and on both sides of the tail skid (located on 4 positions):

**TIE DOWN**

- 32.) On each wheel fairing of the main landing gear:

**2,5 bar**

- 33.) On the nose gear wheel fairing above the cut-out for the valve (left side):

**2,0 bar**

| <i>Document No.:</i> | <i>Issue:</i> | <i>Supersedes Issue:</i> | <i>Date:</i> | <i>Page:</i> |
|----------------------|---------------|--------------------------|--------------|--------------|
| FM-AT01-1010-100E    | A.12          | A.06 (10/02/2004)        | 17/09/2008   | 2 - 16       |

- 34.) On right side of the instrument panel, adjacent to the 12 VDC receptacle (if installed):

**RECEPTACLE  
12 - 14 VDC  
MAX: 8 A**

- 35.) On the instrument panel, adjacent to the ELT remote control switch (if installed):

**ELT-REMOTE-CONTROL  
To activate switch transmitter  
to ARMED!**

- 36.) Directly on the jack up points under the right and left wing-fuselage-intersection:



- 37.) Adjacent to the jack-up points under the right and left wing-fuselage-intersection:

**Jack Point**

- 38.) Above or below the Warning Lights on the instrument panel:

**Reserve**

**ALTERNATOR  
CONTROL**

**FUEL  
PRESSURE**

- 39.) On the lower engine cowling, well visible adjacent to the outlet of the exhaust tailpipe:

**⊥  
— Electric Ground  
Exhaust Port**

| <i>Document No.:</i> | <i>Issue:</i> | <i>Supersedes Issue:</i> | <i>Date:</i> | <i>Page:</i> |
|----------------------|---------------|--------------------------|--------------|--------------|
| FM-AT01-1010-100E    | A.12          | A.06 (10/02/2004)        | 17/09/2008   | 2 - 17       |

- 40.) At the front side of the lower engine cowling, above the cooling air inlet or well visible on the air inlet duct:

**WINTER KIT MUST BE REMOVED ABOVE 15°C (59°F)  
WINTER KIT SHOULD BE INSTALLED BELOW 5°C (41°F)**

- 41.) On the upper surface of each flap near its inboard edge:

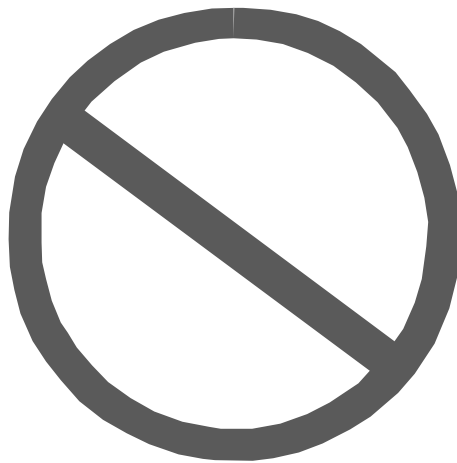

- 42.) On the upper surface of each flap along its trailing edge near the inboard end:

**NO STEP or PUSH**

- 43.) On the upper surface of each elevator near its inboard edge, on both sides of the rudder as well as on the upper surface of the vortex generator on the left side of the fuselage (located on 5 positions per aircraft):

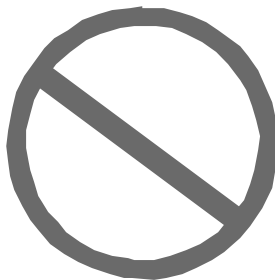

| <i>Document No.:</i> | <i>Issue:</i> | <i>Supersedes Issue:</i> | <i>Date:</i> | <i>Page:</i> |
|----------------------|---------------|--------------------------|--------------|--------------|
| FM-AT01-1010-100E    | A.12          | A.06 (10/02/2004)        | 17/09/2008   | 2 - 18       |

- 44.) This placard is located at the following positions (altogether 6 per aircraft):
- On the upper surface of both winglets along its trailing edge (inboard directed surface).
  - On the upper surface of both elevators along their trailing edges near their inboard end.
  - On both sides of the rudder along the trailing edge.

**NO PUSH**

- 45.) On the firewall adjacent to the brake fluid reservoir:

**! CAUTION !**  
DO NOT use automotive  
brake fluid.  
Refer to POH

- 46.) On the access door for the external power socket in the lower engine cowling (optional, only if external power socket is installed):

**GROUND  
POWER  
12 V DC**

- 47.) In the middle section of the instrument panel below the NAV/COM-equipment and the Multifunctional Display:

**GPS FOR VFR NAVIGATION ONLY**

- 48.) On the right side wall of the centre pedestal adjacent to the adjusting knob:

**Friction Lock  
Power / Prop**

| <i>Document No.:</i> | <i>Issue:</i> | <i>Supersedes Issue:</i> | <i>Date:</i> | <i>Page:</i> |
|----------------------|---------------|--------------------------|--------------|--------------|
| FM-AT01-1010-100E    | A.12          | A.06 (10/02/2004)        | 17/09/2008   | 2 - 19       |



- 49.) In the upper right section of the instrument panel:

ELT and Fire-Extinguisher  
behind Co-Pilot seat  
(if installed)

- 50.) In the middle section of the instrument panel, directly on the left side of the corresponding NAV-/COM-equipment (optional, only if a second NAV-/COM-Transceiver is installed):

COM/NAV 1

COM/NAV 2

- 51.) In the right section of the instrument panel, directly underneath the FLARM-Display Unit (optional):

**FOR INFO IN VMC ONLY**

## 2.17 RESERVED

**[Intentionally left blank]**

| <i>Document No.:</i> | <i>Issue:</i> | <i>Supersedes Issue:</i> | <i>Date:</i> | <i>Page:</i> |
|----------------------|---------------|--------------------------|--------------|--------------|
| FM-AT01-1010-100E    | A.12          | A.06 (10/02/2004)        | 17/09/2008   | 2 - 20       |

## SECTION 3

### EMERGENCY PROCEDURES

|        |  | Page |
|--------|--|------|
| 3.1    | INTRODUCTION                                     | 3-3  |
| 3.2    | AIRSPEEDS FOR EMERGENCY OPERATION                | 3-3  |
| 3.3    | ENGINE FAILURES                                  | 3-4  |
| 3.3.1  | Engine Failure During Take-off Run               | 3-4  |
| 3.3.2  | Engine Failure Immediately After Take-off        | 3-4  |
| 3.3.3  | In-Flight Engine Failure                         | 3-4  |
| 3.3.4  | Power-Off Landing                                | 3-7  |
| 3.4    | PRECAUTIONARY LANDING WITH ENGINE POWER          | 3-7  |
| 3.5    | SMOKE AND FIRE                                   | 3-8  |
| 3.5.1  | Engine Fire on Ground                            | 3-8  |
| 3.5.2  | In-Flight Engine Fire                            | 3-8  |
| 3.5.3  | Electrical Fire and Formation of Smoke on Ground | 3-8  |
| 3.5.4  | In-Flight Electrical Fire and Formation of Smoke | 3-9  |
| 3.5.5  | In-Flight Cabin Fire                             | 3-9  |
| 3.6    | INADVERTENT ENCOUNTER OF ICING CONDITIONS        | 3-9  |
| 3.7    | SPIN RECOVERY PROCEDURE                          | 3-10 |
| 3.8    | POWER OFF GLIDING                                | 3-10 |
| 3.9    | LANDING WITH A FLAT TIRE                         | 3-11 |
| 3.10   | ELECTRICAL POWER SUPPLY SYSTEM MALFUNCTIONS      | 3-11 |
| 3.10.1 | Complete Failure of Electrical System            | 3-11 |
| 3.10.2 | Alternator Failure                               | 3-11 |
| 3.10.3 | Low Voltage Indication                           | 3-12 |

| <i>Dokument No.:</i> | <i>Issue:</i> | <i>Supersedes Issue:</i> | <i>Date:</i> | <i>Page:</i> |
|----------------------|---------------|--------------------------|--------------|--------------|
| FM-AT01-1010-100E    | A.12          | A.11 (30/11/2007)        | 17/09/2008   | 3 - 1        |

|        |  | Page |
|--------|--|------|
| 3.11   | FLAP CONTROL SYSTEM MALFUNCTIONS                           | 3-13 |
| 3.12   | TRIM CONTROL SYSTEM FAILURES                               | 3-14 |
| 3.12.1 | Trim System Inoperative                                    | 3-14 |
| 3.12.2 | Trim Actuator Does Not Stop as Desired                     | 3-14 |
| 3.13   | AVIONICS MALFUNCTIONS                                      | 3-15 |
| 3.13.1 | Complete Avionics Failure                                  | 3-15 |
| 3.13.2 | Receive Mode Failure of COM-Equipment                      | 3-15 |
| 3.13.3 | Transmit Mode Failure of COM-Equipment                     | 3-15 |
| 3.14   | STARTER MALFUNCTION  | 3-15 |
| 3.15   | IN-FLIGHT FAILURES AND MALFUNCTIONS                        | 3-16 |
| 3.15.1 | Self-Actuating Release and Opening of the Canopy in flight | 3-16 |

| <i>Dokument No.:</i> | <i>Issue:</i> | <i>Supersedes Issue:</i> | <i>Date:</i> | <i>Page:</i> |
|----------------------|---------------|--------------------------|--------------|--------------|
| FM-AT01-1010-100E    | A.12          | A.11 (30/11/2007)        | 17/09/2008   | 3 - 2        |

### 3.1 INTRODUCTION

This section provides checklists with the recommended procedures for coping with various emergency situations.

Emergencies caused by aircraft or engine malfunctions are extremely rare if all pre-flight inspections and required maintenance activities are conducted properly.

Nevertheless, if an emergency situation occurs, the herein provided basic procedures are recommended to correct the problem and to master the situation.

However, it is impossible to account for all kinds and combinations of emergency cases that may arise in operation in this manual. Therefore, the pilot must be familiar with the aircraft, its systems, and its flight behaviour. Very important in such cases is a sound judgment and sufficient knowledge of the aircraft and its systems.

### 3.2 AIRSPEEDS FOR EMERGENCY OPERATION

| Airspeed (IAS)                          | [kts] |
|---|-------|
| Manoeuvring Speed $V_A$                 | 112   |
| Speed for best glide                    |       |
| Flaps Up                                | 78    |
| Flaps in Take-off Position              | 73    |
| Precautionary Landing With Engine Power |       |
| Flaps Down                              | 60    |
| Landing Without Engine Power            |       |
| Flaps in Take-off Position              | 65    |
| Flaps Up                                | 70    |

| <i>Dokument No.:</i> | <i>Issue:</i> | <i>Supersedes Issue:</i> | <i>Date:</i> | <i>Page:</i> |
|----------------------|---------------|--------------------------|--------------|--------------|
| FM-AT01-1010-100E    | A.12          | A.11 (30/11/2007)        | 17/09/2008   | 3 - 3        |

### 3.3 ENGINE FAILURES

#### 3.3.1 Engine Failure During Take-off Run

1. Throttle IDLE
2. Brakes APPLY as required

#### 3.3.2 Engine Failure Immediately After Take-off

##### A) ENGINE POWER LOSS

1. Throttle full OPEN
2. Electrical Fuel Pump ON
3. Airspeed 70 KIAS
4. Propeller Control Lever HIGH-RPM Position
5. Fuel Selector Valve SWITCH to fullest tank
6. Choke OFF
7. Carburettor Heat ON
8. Ignition Switch BOTH

**WARNING**

If the engine power cannot be restored immediately, an emergency landing must be initiated considering the local conditions and the circumstances of the particular situation:

Before landing:

9. Fuel Selector Valve OFF
10. Ignition Switch OFF
11. ALT/BAT Switch OFF

**WARNING**

If BAT switch is in OFF Position: Stall warning system is inoperative!

#### 3.3.3 In-Flight Engine Failure

##### A) ENGINE ROUGHNESS

1. Carburettor Heat ON
2. Electrical Fuel Pump ON
3. Ignition Switch SWITCH through the positions L-BOTH, then R-BOTH

| <i>Dokument No.:</i> | <i>Issue:</i> | <i>Supersedes Issue:</i> | <i>Date:</i> | <i>Page:</i> |
|----------------------|---------------|--------------------------|--------------|--------------|
| FM-AT01-1010-100E    | A.12          | A.11 (30/11/2007)        | 17/09/2008   | 3 - 4        |

4. Throttle Do not change position

If roughness continues:

5. Throttle REDUCE to minimum required for flight

6. Precautionary Landing PERFORM

B) LOSS OF OIL PRESSURE

1. Oil Temperature CHECK

If loss of oil pressure below the green arc occurs and the oil temperature remains normal:

2. Land at the nearest airfield

If the loss of oil pressure below the GREEN arc is accompanied by a rise in oil temperature:

3. Throttle REDUCE to minimum required for flight  
 4. Precautionary landing PERFORM  
Be aware that sudden engine failure may occur anytime!

C) LOSS OF FUEL PRESSURE

1. Electrical Fuel Pump ON  
 2. Fuel Selector Valve SWITCH to fullest tank  
 3. Electrical Fuel Pump ON

**NOTE**

The fuel pressure will not be restored after switching fuel tanks until empty fuel lines are refilled again. This process may require up to eight seconds.

4. If the low fuel pressure warning light is still illuminating:  
 Land at the nearest airfield.  
Be aware that sudden engine failure may occur anytime!

D) ENGINE RESTART PROCEDURE WITH STOPPED PROPELLER

1. Non-essential Electrical Equipment OFF  
 2. BAT Switch ON

| <i>Dokument No.:</i> | <i>Issue:</i> | <i>Supersedes Issue:</i> | <i>Date:</i> | <i>Page:</i> |
|----------------------|---------------|--------------------------|--------------|--------------|
| FM-AT01-1010-100E    | A.12          | A.11 (30/11/2007)        | 17/09/2008   | 3 - 5        |

- |    |                         |                        |
|----|-------------------------|------------------------|
| 3. | Propeller Control Lever | HIGH-RPM Position      |
| 4. | Fuel Selector Valve     | SWITCH to fullest tank |
| 5. | Electrical Fuel Pump    | ON                     |
| 6. | Throttle (hot engine)   | 2 cm OPENED            |
|    | (cold engine)           | IDLE                   |
| 7. | Choke (hot engine)      | OFF                    |
|    | (cold engine)           | PULL                   |
| 8. | Ignition Switch         | BOTH                   |
| 9. | Ignition Switch         | START                  |

When power is restored:

- |     |                      |                       |
|-----|----------------------|-----------------------|
| 10. | Oil Pressure         | CHECK                 |
| 11. | Choke                | OFF                   |
| 12. | Electrical Equipment | SWITCH ON as required |
| 13. | Oil Temperature      | CHECK                 |

|             |
|-------------|
| <b>NOTE</b> |
|-------------|

The engine can be started also by windmilling if the airspeed is approx. 120 kts. The altitude loss in glide to reach this airspeed is approximately 1000 ft / 300 m.

#### E) RESTART PROCEDURE WITH PROPELLER IN WINDMILLING CONDITION

With engine power off and airspeeds above 60 kts the propeller is autorotating.

- |    |                         |                        |
|----|-------------------------|------------------------|
| 1. | Airspeed                | 76 KIAS                |
| 2. | BAT Switch              | ON                     |
| 3. | Fuel Selector Valve     | SWITCH to fullest tank |
| 4. | Propeller Control Lever | HIGH-RPM Position      |
| 5. | Electrical Fuel Pump    | ON                     |
| 6. | Ignition Switch         | BOTH                   |
| 7. | Throttle (hot engine)   | 2 cm OPENED            |
|    | (cold engine)           | IDLE                   |
| 8. | Choke (hot engine)      | OFF                    |
|    | (cold engine)           | PULL                   |

When power is restored:

- |     |                      |                       |
|-----|----------------------|-----------------------|
| 9.  | Oil Pressure         | CHECK                 |
| 10. | Choke                | OFF                   |
| 11. | Electrical Equipment | SWITCH ON as required |
| 12. | Oil Temperature      | CHECK                 |

| <i>Dokument No.:</i> | <i>Issue:</i> | <i>Supersedes Issue:</i> | <i>Date:</i> | <i>Page:</i> |
|----------------------|---------------|--------------------------|--------------|--------------|
| FM-AT01-1010-100E    | A.12          | A.11 (30/11/2007)        | 17/09/2008   | 3 - 6        |

### 3.3.4 Power-Off Landing

#### A) EMERGENCY LANDING WITHOUT ENGINE POWER

1. Airspeed
 

|                            |         |
|----------------------------|---------|
| Flaps in Landing Position  | 60 KIAS |
| Flaps in Take-off Position | 65 KIAS |
| Flaps in Cruise Position   | 70 KIAS |
2. Fuel Selector Valve OFF
3. Ignition Switch OFF
4. Seat Belts and Harnesses TIGHT
5. COM (ATC) REPORT location and intention
6. ALT/BAT Switch OFF

|                |
|----------------|
| <b>WARNING</b> |
|----------------|

If ALT/BAT Switch is in OFF-Position: Stall warning system is inoperative!

### 3.4 PRECAUTIONARY LANDING WITH ENGINE POWER

|             |
|-------------|
| <b>NOTE</b> |
|-------------|

It may be advisable to make an off-airport landing while power is still available, particularly if the continuation of the flight represents a danger for the occupants or the aircraft. Reasons for that may be unexpected bad weather conditions, low fuel, technical trouble, or the physical condition of an occupant deteriorates strongly.

1. Locate Suitable Field CONSIDER wind direction, terrain and obstructions.
2. Seat Belts and Harnesses TIGHT
3. Initiate Descent
4. Selected Field FLY OVER (Altitude > 500 ft), checking conditions (wind direction, obstructions, slope and condition of the field)
5. CHECK before turning into final approach:
 

|                         |                   |
|-------------------------|-------------------|
| Throttle                | AS REQUIRED       |
| Propeller Control Lever | HIGH-RPM Position |
| Carburettor Heat        | ON                |
| Electrical Fuel Pump    | ON                |
| Flaps                   | Extended          |
| Airspeed                | 60 KIAS           |
6. Touch down with lowest possible airspeed.

| <i>Dokument No.:</i> | <i>Issue:</i> | <i>Supersedes Issue:</i> | <i>Date:</i> | <i>Page:</i> |
|----------------------|---------------|--------------------------|--------------|--------------|
| FM-AT01-1010-100E    | A.12          | A.11 (30/11/2007)        | 17/09/2008   | 3 - 7        |



7. After touchdown:
- |                     |                   |
|---------------------|-------------------|
| Brakes              | APPLY as required |
| Fuel Selector Valve | OFF               |
| Ignition Switch     | OFF               |
| ALT/BAT Switch      | OFF               |

### 3.5 SMOKE AND FIRE

#### 3.5.1 Engine Fire On Ground

- |    |                     |           |
|----|---------------------|-----------|
| 1. | Fuel Selector Valve | OFF       |
| 2. | Throttle            | FULL OPEN |
| 3. | ALT/BAT Switch      | OFF       |
| 4. | Ignition Switch     | OFF       |
| 5. | Aircraft            | EVACUATE  |

#### 3.5.2 In-Flight Engine Fire

- |    |  |                   |
|----|--|-------------------|
| 1. | Fuel Selector Valve  | OFF               |
| 2. | Airspeed   | 90 KIAS           |
| 3. | Flaps  | TAKE-OFF Position |
| 4. | Throttle   | FULL OPEN         |
| 5. | Cabin Heat   | OFF               |
| 6. | Canopy slide-window  | FULL OPEN         |
| 7. | Proceed with Power-Off Landing in accordance with 3.3.4 A) |                   |

#### 3.5.3 Electrical Fire and Formation of Smoke on Ground

- |    |                |     |
|----|----------------|-----|
| 1. | ALT/BAT Switch | OFF |
|----|----------------|-----|

If engine is running:

- |    |                                  |                      |
|----|----------------------------------|----------------------|
| 2. | Throttle                         | IDLE                 |
| 3. | Fuel Selector Valve              | OFF                  |
| 4. | Ignition Switch                  | OFF                  |
| 5. | Canopy                           | OPEN                 |
| 6. | Fire Extinguisher (if installed) | ACTIVATE as required |

| <i>Dokument No.:</i> | <i>Issue:</i> | <i>Supersedes Issue:</i> | <i>Date:</i> | <i>Page:</i> |
|----------------------|---------------|--------------------------|--------------|--------------|
| FM-AT01-1010-100E    | A.12          | A.11 (30/11/2007)        | 17/09/2008   | 3 - 8        |

**3.5.4 In-Flight Electrical Fire and Formation of Smoke**

- |    |                                  |                      |
|----|----------------------------------|----------------------|
| 1. | BAT Switch                       | OFF                  |
| 2. | Cabin Vents                      | OPEN                 |
| 3. | Canopy slide-window              | FULL OPEN            |
| 4. | Fire Extinguisher (if installed) | ACTIVATE as required |

**3.5.5 In-Flight Cabin Fire**

- |    |                                       |                      |
|----|---------------------------------------|----------------------|
| 1. | BAT Switch                            | OFF                  |
| 2. | Cabin Vents                           | OPEN                 |
| 3. | Cabin Heat                            | OFF                  |
| 4. | Fire Extinguisher (if installed)      | ACTIVATE as required |
| 5. | If necessary, prepare safety landing. |                      |

**3.6 INADVERTENT ENCOUNTER OF ICING CONDITIONS**

In the event of an inadvertent icing encounter, use the following procedure:

- |    |  |          |
|----|--|----------|
| 1. | Carburettor Heat   | ON       |
| 2. | Propeller RPM  | INCREASE |
| 3. | Cabin Heat   | ON       |
| 4. | Immediately leave the region in which the icing occurred.<br>(Change flight altitude and/or turn back) |          |
| 5. | Move the control surfaces periodically, to keep them movable.  |          |

**CAUTION**

With ice accumulation on the wing leading edge, stalling speed increases.

**CAUTION**

With ice accumulation on the wing leading edge, the readings of the airspeed indicator, of the altimeter, and of the vertical speed indicator may be incorrect. The stall warning system may be inoperative or may not work correctly.

| <i>Dokument No.:</i> | <i>Issue:</i> | <i>Supersedes Issue:</i> | <i>Date:</i> | <i>Page:</i> |
|----------------------|---------------|--------------------------|--------------|--------------|
| FM-AT01-1010-100E    | A.12          | A.11 (30/11/2007)        | 17/09/2008   | 3 - 9        |

### 3.7 SPIN RECOVERY PROCEDURE

- |    |                                  |  |
|----|----------------------------------|--|
| 1. | Rudder                           | APPLY FULL DEFLECTION OPPOSITE to direction of rotation                |
| 2. | Throttle retard to               | IDLE   |
| 3. | Elevator control move forward to | NEUTRAL (far enough to terminate the stall)                            |
| 4. | Rudder return to                 | NEUTRAL as soon as the rotation stops                                  |
| 5. | Ailerons return to               | NEUTRAL  |
| 6. | Flaps                            | RETRACT if extended  |
| 7. | Rudder return to                 | NEUTRAL as soon as the rotation stops                                  |
| 8. | Elevator Control                 | cautiously PULL OUT of the dive by applying back pressure on the stick |

Make a smooth recovery from the dive to regain level flight attitude. Do not exceed  $V_{NE}$ .

|                |
|----------------|
| <b>WARNING</b> |
|----------------|

During recovery of spinning the sequence of actions stated above is mandatory !

### 3.8 POWER OFF GLIDING

Depending on the flight altitude and the current wind conditions, the achievable gliding distances may be different to reach a suitable field or a close air field.

For an optimal power off gliding, consider the following:

- |    |                          |           |
|----|--------------------------|-----------|
| 1. | Flaps                    | RETRACTED |
| 2. | Airspeed                 | 78 KIAS   |
| 3. | Demonstrated Glide Ratio | 14        |
- That means, a glide distance of 4 km results in an altitude loss of 1000 ft. (with no Wind)

|             |
|-------------|
| <b>NOTE</b> |
|-------------|

Headwinds or tailwinds have a great influence on the achievable gliding distance.

| <i>Dokument No.:</i> | <i>Issue:</i> | <i>Supersedes Issue:</i> | <i>Date:</i> | <i>Page:</i> |
|----------------------|---------------|--------------------------|--------------|--------------|
| FM-AT01-1010-100E    | A.12          | A.11 (30/11/2007)        | 17/09/2008   | 3 - 10       |

### 3.9 LANDING WITH A FLAT TIRE

For a landing with a suspect or defective tire use the following procedure:

1. Flaps LANDING Position
2. Perform touch down on that side of the runway that is opposite to the defective tire, to have the complete width of the runway to correct direction changes caused by the defective tire.
3. Perform touch down with intact main tire first.  
Touch down nose wheel as soon as possible to obtain a better controllability of the aircraft on ground.
4. While taxiing, move aileron control fully to the side of the intact main tire, to unload the defective one.
5. When landing with a flat nose wheel tyre: Touch down with minimum speed  
Hold nose wheel off the ground as long as possible.

### 3.10 ELECTRICAL POWER SUPPLY SYSTEM MALFUNCTIONS

#### 3.10.1 Complete Failure of Electrical System

1. Battery Circuit Breaker RESET if tripped
2. ALT/BAT Switch CHECK if ON
3. If power is not restored Land at the nearest airfield if practical

#### 3.10.2 Alternator Failure

ALTERNATOR Warning Light illuminates:

1. ALTERNATOR Switch SWITCH OFF then ON
2. Alternator Circuit Breaker RESET if tripped

| <i>Dokument No.:</i> | <i>Issue:</i> | <i>Supersedes Issue:</i> | <i>Date:</i> | <i>Page:</i> |
|----------------------|---------------|--------------------------|--------------|--------------|
| FM-AT01-1010-100E    | A.12          | A.11 (30/11/2007)        | 17/09/2008   | 3 - 11       |



- C) Low voltage indication while landing (needle on green-red shaded ARC or below)
1. After Landing Proceed in accordance with 3.10.3 A)

**WARNING**

Whenever the needle of the voltmeter is within the RED ARC, land at the nearest airfield to eliminate the problem before continuing the flight.

### 3.11 FLAP CONTROL SYSTEM MALFUNCTIONS

Flap position indicator or flap actuator malfunction.

1. "Flaps" Circuit Breaker RESET, if tripped
2. Flap Position CHECK visually at the left wing
3. Airspeed within the WHITE RANGE on the  
airspeed indicator
4. Flap Switch Switch through all positions.

If the flap actuator is inoperative or the flap position indicator reading is incorrect, the landing approach should be conducted with a safe airspeed for the current flap position.

**WARNING**

Landing with flaps not in the landing position increases the stalling speed and the landing distance.

| <i>Dokument No.:</i> | <i>Issue:</i> | <i>Supersedes Issue:</i> | <i>Date:</i> | <i>Page:</i> |
|----------------------|---------------|--------------------------|--------------|--------------|
| FM-AT01-1010-100E    | A.12          | A.11 (30/11/2007)        | 17/09/2008   | 3 - 13       |

### 3.12 TRIM CONTROL SYSTEM FAILURES

#### 3.12.1 Trim System Inoperative

- |    |                                 |  |
|----|---------------------------------|--|
| 1. | "Trim Actuator" Circuit Breaker | RESET, if tripped  |
| 2. | Trim Switch                     | PRESS "Nose UP" and then<br>"Nose Down" for several times. |

**NOTE**

An inoperative trim system does not affect the aircraft controllability. However, the control stick forces are considerably higher and may reach up to 100 N.

3. Land as soon as practical.

#### 3.12.2 Trim Actuator Does Not Stop as Desired

- |    |                                 |   |
|----|---------------------------------|---|
| 1. | Control Stick                   | HOLD in position                        |
| 2. | "Trim Actuator" Circuit Breaker | PULL                                    |
| 3. | Trim Switch                     | CHECK, whether pressed,<br>jammed, etc. |

If the problem is obvious, and can be solved:

- |    |                                 |       |
|----|---------------------------------|-------|
| 4. | "Trim Actuator" Circuit Breaker | RESET |
|----|---------------------------------|-------|

**NOTE**

The trim setting from full nose-down to full nose-up trim position, or vice versa, takes approx. 8 seconds.

If the problem cannot be eliminated:

4. Land at nearest airfield.

| <i>Dokument No.:</i> | <i>Issue:</i> | <i>Supersedes Issue:</i> | <i>Date:</i> | <i>Page:</i> |
|----------------------|---------------|--------------------------|--------------|--------------|
| FM-AT01-1010-100E    | A.12          | A.11 (30/11/2007)        | 17/09/2008   | 3 - 14       |

### 3.13 AVIONICS MALFUNCTIONS

#### 3.13.1 Complete Avionics Failure

1. AVIONICS Master Switch SWITCH Off then On. The avionics main switch is an automatic circuit protective Switch. If the switch trips again:
2. Land at the nearest suitable airfield.

#### 3.13.2 Receive Mode Failure of COM-Equipment

1. Push-to-Talk (PPT) Switch CHECK pilot's and co-pilot's PTT-Switches whether pressed, jammed, etc. (check also on transceiver display).  
CHECK connectors.
2. Head-Set SWITCH Off squelch momentarily.  
If no noise is audible:  
CHECK Head-Set connectors.

#### 3.13.3 Transmit Mode Failure of COM-Equipment

1. "T" Symbol CHECK whether displayed while Transmitting.
2. Selected Frequency CHECK
3. Microphone CHECK, if necessary replace Head-set.

If the problem cannot be eliminated, set the transponder code to 7600 if required.

### 3.14 STARTER MALFUNCTION

During engine start, the starter does not decouple from engine (a continuing and excessive howling tone is audible).

1. Throttle IDLE
2. Ignition Switch OFF
3. Repair damage before conducting planned flight.

| <i>Dokument No.:</i> | <i>Issue:</i> | <i>Supersedes Issue:</i> | <i>Date:</i> | <i>Page:</i> |
|----------------------|---------------|--------------------------|--------------|--------------|
| FM-AT01-1010-100E    | A.12          | A.11 (30/11/2007)        | 17/09/2008   | 3 - 15       |



### 3.15 IN-FLIGHT FAILURES AND MALFUNCTIONS

#### 3.15.1 Self-Actuating Release and Opening of the Canopy in flight

In the case of a self-actuating release and opening of the canopy in flight, a stationary canopy opening angle of about  $20^{\circ} \pm 10^{\circ}$ , depending on the flight condition, is reached where the aerodynamic forces exerted on the canopy are in equilibrium. Since the canopy is opened forwards, the canopy can not be torn off by the air flow as a consequence of the self-actuating opening in flight. Even though the airflow conditions around the aircraft changes considerably with an open canopy in flight, the aircraft remains fully controllable. Initial flight attitude changes can be easily corrected. Do not unbuckle the seat belt in order to close the canopy. During solo flights, carefully try to close the canopy without neglecting the flight tasks and pilot responsibilities. If this is not possible, continue the flight with the open canopy and land at the nearest airfield.

1. Keep calm, an imminent danger is not given.
2. Flight Attitude  
  
Airspeed  
  
Surrounding Airspace  
  
Canopy
  - Stabilize flight attitude, establish a stationary horizontal level flight condition considering the actual conditions.  
65 – 75 KIAS
  - Check for obstacles and other traffic.
  - Close and lock canopy in flight if possible. Check the canopy locking and the position of the Canopy Locking Lever continuously until landing.  
If this is not possible, continue flight with open canopy and land at the nearest airfield.

| <i>Dokument No.:</i> | <i>Issue:</i> | <i>Supersedes Issue:</i> | <i>Date:</i> | <i>Page:</i> |
|----------------------|---------------|--------------------------|--------------|--------------|
| FM-AT01-1010-100E    | A.12          | A.11 (30/11/2007)        | 17/09/2008   | 3 - 16       |

## SECTION 4

### NORMAL PROCEDURES

|        |  | Page |
|--------|--|------|
| 4.1    | INTRODUCTION   | 4-2  |
| 4.2    | AIRSPEEDS FOR NORMAL OPERATION                         | 4-3  |
| 4.3    | RESERVED   | 4-5  |
| 4.4    | PRE-FLIGHT INSPECTION                                  | 4-6  |
| 4.4.1  | Daily Pre-flight Check                                 | 4-6  |
| 4.4.2  | Check Before Every Flight                              | 4-11 |
| 4.5    | CHECKLISTS FOR NORMAL PROCEDURES                       | 4-13 |
| 4.5.1  | Before Engine Start-up                                 | 4-13 |
| 4.5.2  | Engine Start-up  | 4-13 |
| 4.5.3  | Before Taxiing   | 4-14 |
| 4.5.4  | Taxiing  | 4-14 |
| 4.5.5  | Before Take-off (at the Taxi Holding Position)         | 4-15 |
| 4.5.6  | Take-off   | 4-16 |
| 4.5.7  | Climb  | 4-16 |
| 4.5.8  | Cruise   | 4-17 |
| 4.5.9  | Descent  | 4-17 |
| 4.5.10 | Landing  | 4-17 |
| 4.5.11 | Balked Landing   | 4-18 |
| 4.5.12 | After Landing  | 4-18 |
| 4.5.13 | Engine Shutdown  | 4-18 |
| 4.5.14 | Flight in Heavy Rain and/or with Strongly Soiled Wings | 4-19 |
|        | Intentionally left blank                               | 4-20 |

| <i>Dokument No.:</i> | <i>Issue:</i> | <i>Supersedes Issue:</i> | <i>Date:</i> | <i>Page:</i> |
|----------------------|---------------|--------------------------|--------------|--------------|
| FM-AT01-1010-100E    | A.18          | A.12 (17/09/2008)        | 29/11/2010   | 4 - 1        |

## 4.1 INTRODUCTION

This section provides normal operating procedure checklists for the aircraft as well as recommended airspeeds.

Additional information is provided in the Operators Manual for ROTAX® engine Type 912 series and in the Operation and Installation Manual of mt-Propeller®, latest revision.

Normal procedures associated with optional equipment can be found in Section 9.

| <i>Dokument No.:</i> | <i>Issue:</i> | <i>Supersedes Issue:</i> | <i>Date:</i> | <i>Page:</i> |
|----------------------|---------------|--------------------------|--------------|--------------|
| FM-AT01-1010-100E    | A.18          | A.12 (17/09/2008)        | 29/11/2010   | 4 - 2        |

## 4.2 AIRSPEEDS FOR NORMAL OPERATION

The following airspeeds are based on the maximum take-off weight of 750 kg. They may be also used for any lower operational weight.

| <b>TAKE-OFF</b>  |      |
|--|------|
| Airspeed (IAS)   | KIAS |
| Normal Climb Speed at 50 Feet<br>(Flaps in Take-off Position (17°))                | 60   |
| Best Rate of Climb Speed $V_Y$ at Sea Level<br>(Flaps UP (Cruise Position))        | 65   |
| Best Angle of Climb Speed $V_X$ at sea Level<br>(Flaps in Take-off Position (17°)) | 60   |

| <b>LANDING</b>  |      |
|---|------|
| Airspeed (IAS)  | KIAS |
| Final Approach Speed for Landing<br>(Flaps in Landing Position (35°)) | 60   |
| Balked Landing<br>(Flaps in Landing Position (35°))                   | 60   |
| Maximum Demonstrated Crosswind Velocity for<br>Take-off or Landing    | 15   |

| <i>Dokument No.:</i> | <i>Issue:</i> | <i>Supersedes Issue:</i> | <i>Date:</i> | <i>Page:</i> |
|----------------------|---------------|--------------------------|--------------|--------------|
| FM-AT01-1010-100E    | A.18          | A.12 (17/09/2008)        | 29/11/2010   | 4 - 3        |

**CRUISE**

| Airspeed (KIAS)                       |          | KIAS |
|---------------------------------------|----------|------|
| Manoeuvring Speed                     | $V_A$    | 112  |
| Maximum Turbulent Air Operating Speed | $V_{NO}$ | 130  |
| Maximum Flap Extended Speed           | $V_{FE}$ | 90   |

| <i>Dokument No.:</i> | <i>Issue:</i> | <i>Supersedes Issue:</i> | <i>Date:</i> | <i>Page:</i> |
|----------------------|---------------|--------------------------|--------------|--------------|
| FM-AT01-1010-100E    | A.18          | A.12 (17/09/2008)        | 29/11/2010   | 4 - 4        |

### 4.3 RESERVED

[Intentionally left blank]

| <i>Dokument No.:</i> | <i>Issue:</i> | <i>Supersedes Issue:</i> | <i>Date:</i> | <i>Page:</i> |
|----------------------|---------------|--------------------------|--------------|--------------|
| FM-AT01-1010-100E    | A.18          | A.12 (17/09/2008)        | 29/11/2010   | 4 - 5        |

## 4.4 PRE-FLIGHT INSPECTION

### 4.4.1 Daily Pre-flight Check

#### A) CABIN

- |     |   |                                 |
|-----|---|---------------------------------|
| 1.  | Papers  | CHECK on board                  |
| 2.  | Ignition Key                                  | REMOVED                         |
| 3.  | BAT Switch                                    | ON                              |
| 4.  | Warning Lights (Alternator,<br>Fuel pressure) | ILLUMINATE                      |
| 5.  | Engine Instruments                            | CHECK                           |
| 6.  | Fuel Quantity                                 | CHECK                           |
| 7.  | External Lights                               | CHECK for proper operation      |
| 8.  | BAT Switch                                    | OFF                             |
| 9.  | Foreign Objects                               | CHECK and REMOVE                |
| 10. | ELT   | CHECK                           |
| 11. | Baggage                                       | STOWED and STRAPPED             |
| 12. | Canopy  | CHECK for damages and cleanness |

| <i>Dokument No.:</i> | <i>Issue:</i> | <i>Supersedes Issue:</i> | <i>Date:</i> | <i>Page:</i> |
|----------------------|---------------|--------------------------|--------------|--------------|
| FM-AT01-1010-100E    | A.18          | A.12 (17/09/2008)        | 29/11/2010   | 4 - 6        |

B) EXTERIOR CHECK, Visual Inspection

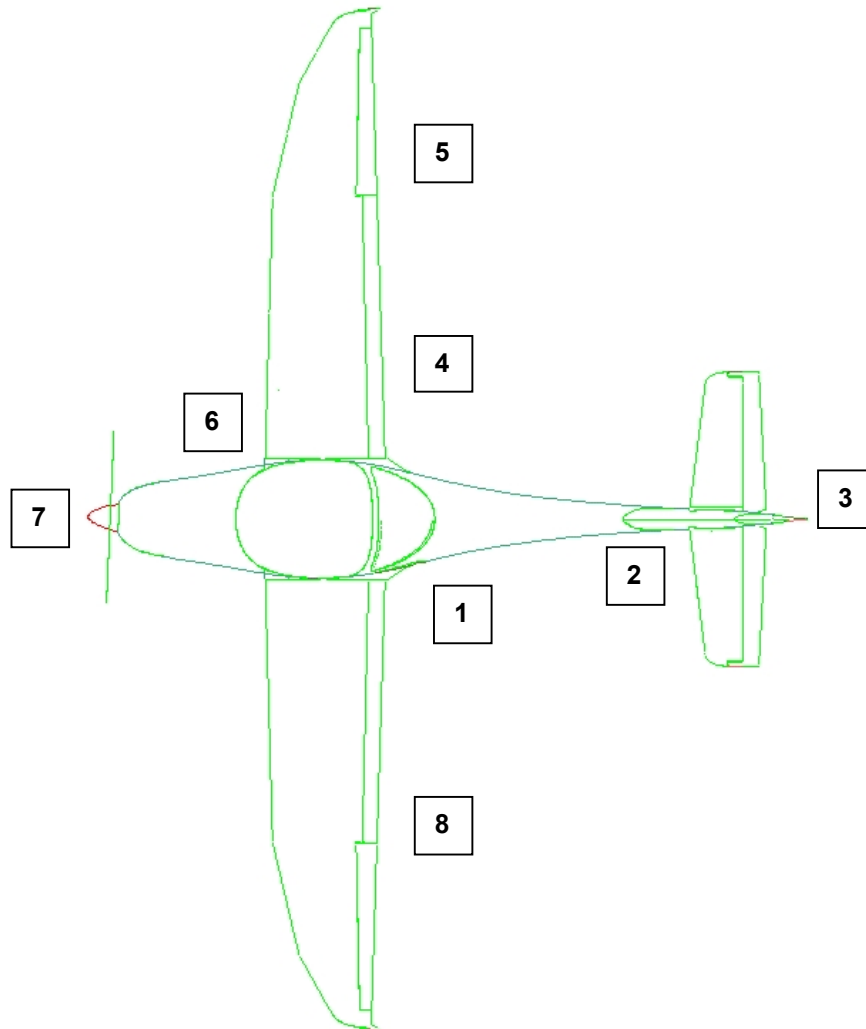

**CAUTION**

Visual Inspection herein means the following:  
 Inspection for mechanical damages, dirt, cracks, delamination, excessive play, looseness, leakages, incorrect attachment, foreign objects and general condition.  
 Control surfaces: additional functional check for free movement.

1. Left Main Landing Gear

- a) Landing Gear Strut
- b) Wheel Fairing

Visual Inspection  
 Visual Inspection

| <i>Dokument No.:</i> | <i>Issue:</i> | <i>Supersedes Issue:</i> | <i>Date:</i> | <i>Page:</i> |
|----------------------|---------------|--------------------------|--------------|--------------|
| FM-AT01-1010-100E    | A.18          | A.12 (17/09/2008)        | 29/11/2010   | 4 - 7        |



- |                       |                   |
|-----------------------|-------------------|
| c) Tire Pressure      | CHECK             |
| d) Tire Slip Marking  | CHECK             |
| e) Tire, Wheel, Brake | Visual Inspection |
| f) Brake Chocks       | REMOVE            |

**2. Tail Boom**

- |                    |                   |
|--------------------|-------------------|
| a) Tail Boom Shell | Visual Inspection |
| b) Skid Plate      | Visual Inspection |
| c) Tail Tie-Down   | DISCONNECT        |

**3. Empennage**

- |                          |  |
|--------------------------|--|
| a) Elevator              | Visual Inspection  |
| b) Horizontal Stabilizer | Visual Inspection  |
| c) Rudder                | Visual Inspection,<br>CHECK: fitting and bolt<br>connection, proper control cable<br>connection and screw locking. |
| d) Vertical Stabilizer   | Visual Inspection  |

**4. Right Main Landing gear**

- |                       |                   |
|-----------------------|-------------------|
| a) Landing Gear Strut | Visual Inspection |
| b) Wheel Fairing      | Visual Inspection |
| c) Tire Pressure      | CHECK             |
| d) Tire Slip Marking  | CHECK             |
| e) Tire, Wheel, Brake | Visual Inspection |
| f) Brake Chocks       | REMOVE            |

**5. Right Wing**

- |                                  |   |
|----------------------------------|---|
| a) Entire Wing Surface           | Visual Inspection   |
| b) Fuel Vent                     | CHECK if clear  |
| c) Flap                          | Visual Inspection   |
| d) Aileron and Inspection Window | Visual Inspection   |
| e) Wing Tip, NAV-Lights and ACL  | Visual Inspection   |
| f) Fuel Level                    | CHECK with dipstick and verify<br>with the indicated fuel<br>level in the cockpit |
| g) Fuel tank filler cap          | CHECK if closed   |
| h) Fuel Tank Drain Valve         | DRAIN, check for water<br>and deposits  |
| i) Wing Tie-Down                 | DISCONNECT  |

| <i>Dokument No.:</i> | <i>Issue:</i> | <i>Supersedes Issue:</i> | <i>Date:</i> | <i>Page:</i> |
|----------------------|---------------|--------------------------|--------------|--------------|
| FM-AT01-1010-100E    | A.18          | A.12 (17/09/2008)        | 29/11/2010   | 4 - 8        |

6. Nose Section, Cowling

**WARNING**

Before cranking the propeller: Switch OFF the battery and Ignition Circuits, activate Parking brake.

**WARNING**

**Risk of burning and scaldings**

Carry out pre-flight checks on the cold engine only !

a) Check Oil level

Prior to the oil check, turn the propeller several times in the direction of engine rotation to pump oil from the engine back into the oil tank.

This process will be finished when air is returning back to the oil tank and can be noticed by a rustling sound from the open oil tank. Now check oil level, which should be between the min. and max. markings of the oil dipstick but must never be below min. marking. The volume difference between the min. and max. markings is 0.45 litre.

**NOTE**

The oil specification in paragraph 1.9.1 has to be observed !

b) Check Coolant Level

Verify coolant level in the **expansion tank**, replenish as required.  
The coolant level must be at least 2/3 of the expansion tank.

Verify coolant level in the **overflow bottle**, replenish as required.  
The coolant level must be between the min. and max. markings on the overflow bottle.

**NOTE**

The coolant specification in paragraph 1.9.2 has to be observed !

| <i>Dokument No.:</i> | <i>Issue:</i> | <i>Supersedes Issue:</i> | <i>Date:</i> | <i>Page:</i> |
|----------------------|---------------|--------------------------|--------------|--------------|
| FM-AT01-1010-100E    | A.18          | A.12 (17/09/2008)        | 29/11/2010   | 4 - 9        |

- |                                  |                                     |
|----------------------------------|-------------------------------------|
| c) Air Intakes (4 NACA Intakes)  | CHECK if clear                      |
| d) Radiator / Oil Cooler Intake  | CHECK if free from obstructions     |
| e) Cowling                       | Visual Inspection                   |
|                                  | CHECK Camloc fasteners              |
| f) Propeller                     | Visual Inspection                   |
| g) Propeller Blades              | CHECK for cracks and other damages  |
| h) Spinner Dome                  | Visual Inspection                   |
| i) Electr. Fuel Pump Drain Valve | DRAIN, check for water and deposits |

**7. Nose Landing Gear**

- |                             |                   |
|-----------------------------|-------------------|
| a) Nose Gear Strut          | Visual Inspection |
| b) Wheel Fairing            | Visual Inspection |
| c) Tire Pressure            | CHECK             |
| d) Tire Slip Marking        | CHECK             |
| e) Tire, Wheel              | Visual Inspection |
| f) Shock Absorber Unit      | Visual Inspection |
| g) Brake Chocks and Tow Bar | REMOVE            |

**8. Left Wing**

- |                                  |  |
|----------------------------------|--|
| a) Entire Wing Surface           | Visual Inspection  |
| b) Fuel Vent                     | CHECK if clear   |
| c) Battery                       | ON   |
| d) Stall Warning System          | Carefully move the small plate at the transmitter upwards until the stall warning is audible |
| e) Battery                       | OFF  |
| f) Pitot / Static Head           | REMOVE cover,<br>CHECK if all holes are clear  |
| g) Wing Tip, NAV-Lights and ACL  | Visual Inspection  |
| h) Aileron and Inspection Plates | Visual Inspection  |
| i) Fuel Level                    | CHECK with dipstick justify with the indicated fuel level in the cockpit                     |
| j) Fuel Tank Drain Valve         | DRAIN, check for water and deposits  |
| k) Fuel tank filler cap          | CHECK if closed  |
| l) Flap                          | Visual Inspection  |
| m) Wing Tie-Down                 | DISCONNECT   |

| <i>Dokument No.:</i> | <i>Issue:</i> | <i>Supersedes Issue:</i> | <i>Date:</i> | <i>Page:</i> |
|----------------------|---------------|--------------------------|--------------|--------------|
| FM-AT01-1010-100E    | A.18          | A.12 (17/09/2008)        | 29/11/2010   | 4 - 10       |

**4.4.2 Check Before Every Flight**

|             |
|-------------|
| <b>NOTE</b> |
|-------------|

The fuel level dipstick for checking the fuel tank level is stored on the inner side of the baggage compartment door.

1. Daily Pre-flight Inspection completed?
2. Tow Bar CHECK if removed.
3. Fuel Quantity CHECK with fuel level dipstick and justify with indicated fuel level in the cockpit.

|             |
|-------------|
| <b>NOTE</b> |
|-------------|

If AVGAS 100LL or mixtures of different grades of fuel are filled into the tanks a less amount of fuel will be indicated as actual in the tank.  
This circumstance must be considered during the flight.

|                |
|----------------|
| <b>WARNING</b> |
|----------------|

Before cranking the propeller: Switch OFF the battery and Ignition Circuits, activate Parking brake.

|                |
|----------------|
| <b>WARNING</b> |
|----------------|

**Risk of burning and scaldings**

Carry out pre-flight checks on the cold engine only !

4. Check Oil level 

Prior to the oil check, turn the propeller several times in the direction of engine rotation to pump oil from the engine back into the oil tank.

This process will be finished when air is returning back to the oil tank and can be noticed by a rustling sound from the open oil tank. Now check oil level, which should be between the min. and max. markings of the oil dipstick but must never be below min. marking.

| <i>Dokument No.:</i> | <i>Issue:</i> | <i>Supersedes Issue:</i> | <i>Date:</i> | <i>Page:</i> |
|----------------------|---------------|--------------------------|--------------|--------------|
| FM-AT01-1010-100E    | A.18          | A.12 (17/09/2008)        | 29/11/2010   | 4 - 11       |

The volume difference between the min. and max. markings is 0.45 litre.

|             |
|-------------|
| <b>NOTE</b> |
|-------------|

The oil specification in paragraph 1.9.1 has to be observed !

#### 5. Check Coolant Level

Verify coolant level in the **overflow bottle**, replenish as required.  
The coolant level must be between the min. and max. markings on the overflow bottle.

|             |
|-------------|
| <b>NOTE</b> |
|-------------|

The coolant specification in paragraph 1.9.2 has to be observed !

- |   |  |
|---|--|
| <ul style="list-style-type: none"> <li>6. Tie-Down Straps</li> <li>7. Baggage door</li> <li>8. Pitotcover</li> <li>9. Flight Controls</li> <li>10. Carburettor Heat</li> <li>11. Cabin Heat</li> <li>12. Choke</li> <li>13. Throttle</li> <li>14. Propeller Control Lever</li> <li>15. Trim System (indication and function)</li> <li>16. Flaps (Pos. indication and function)</li> </ul> | <ul style="list-style-type: none"> <li>Removed.</li> <li>CHECK if closed</li> <li>CHECK if removed.</li> <li>CHECK for proper operation</li> <li>CHECK for free movement, then set OFF-Position</li> <li>CHECK for free movement, then set OFF-Position</li> <li>CHECK for free movement, CHECK if self-resetting (move throttle)</li> <li>CHECK for free movement, then set IDLE-Position</li> <li>CHECK for free movement, then set in HIGH-RPM Position</li> <li>CHECK, set full "Nose-Down" and "Nose-UP" Positions</li> <li>CHECK, full extended and retract</li> </ul> |
|---|--|

| <i>Dokument No.:</i> | <i>Issue:</i> | <i>Supersedes Issue:</i> | <i>Date:</i> | <i>Page:</i> |
|----------------------|---------------|--------------------------|--------------|--------------|
| FM-AT01-1010-100E    | A.18          | A.12 (17/09/2008)        | 29/11/2010   | 4 - 12       |

## 4.5 CHECKLISTS FOR NORMAL PROCEDURES

### 4.5.1 Before Engine Start-up

- |     |                             |   |
|-----|-----------------------------|---|
| 1.  | Daily Pre-flight Check      | COMPLETED   |
| 2.  | Passenger Briefing          | COMPLETED   |
| 3.  | Seats                       | ADJUSTED as required  |
| 4.  | Seat Belts and Harnesses    | FASTENED and TIGHTENED  |
| 5.  | Canopy                      | CLOSED and LATCHED<br>CHECK if canopy locking can<br>release due to vibrations. |
| 6.  | Parking Brake               | SET   |
| 7.  | Control Stick               | CHECK for free movement and<br>correct control surface deflections              |
| 8.  | Fuel Selector Valve         | SWITCH to fullest tank  |
| 9.  | Carburettor Heat            | OFF   |
| 10. | Throttle                    | IDLE  |
| 11. | Propeller Control Lever     | HIGH-RPM Position   |
| 12. | AVIONICS Switch             | OFF   |
| 13. | ALT/BAT Switch              | ON  |
| 14. | Generator Warning Light     | ILLUMINATES   |
| 15. | Fuel Pressure Warning Light | ILLUMINATES   |
| 16. | Anti Collision Light        | ON  |
| 17. | Circuit Breakers            | CHECK if all pushed in  |

### 4.5.2 Engine Start-up

- |    |                             |   |
|----|-----------------------------|---|
| 1. | Electrical Fuel Pump        | ON  |
| 2. | Fuel Pressure Warning Light | Does not illuminate   |
| 3. | Throttle                    | IDLE  |
|    | - Cold Engine               | 2 cm OPENED   |
|    | - Hot Engine                |   |
| 4. | Choke                       | PULL  |
|    | - Cold Engine               | OFF   |
|    | - Hot Engine                | SET   |
| 5. | Brakes                      | SET   |
| 6. | Propeller Area              | CHECK if clear  |
| 7. | Ignition Switch             | START   |
| 8. | Oil Pressure Gauge          | CHECK, oil pressure should build<br>up into the green arc range within<br>10 seconds. |

|                |
|----------------|
| <b>CAUTION</b> |
|----------------|

If the oil pressure does not reach at least 1.5 bar within 10 seconds after engine start, immediately shut down the engine !

| <i>Dokument No.:</i> | <i>Issue:</i> | <i>Supersedes Issue:</i> | <i>Date:</i> | <i>Page:</i> |
|----------------------|---------------|--------------------------|--------------|--------------|
| FM-AT01-1010-100E    | A.18          | A.12 (17/09/2008)        | 29/11/2010   | 4 - 13       |

|             |
|-------------|
| <b>NOTE</b> |
|-------------|

The oil pressure may rise into the YELLOW ARC RANGE, as long as the oil temperature is below the normal operating temperature.

|             |
|-------------|
| <b>NOTE</b> |
|-------------|

If engine does not start within 10 seconds, disengage the starter and try again after a cooling down phase of at least 2 minutes. DO NOT continuously operate the starter motor for a time period of more than 10 seconds.

|             |
|-------------|
| <b>NOTE</b> |
|-------------|

For a successful engine start, the propeller speed must reach at least 100 RPM. This should be considered when having engine start-up problems during cold weather operations or with a partially discharged battery.

- |     |                         |             |
|-----|-------------------------|-------------|
| 9.  | Generator Warning Light | OFF         |
| 10. | NAV Lights              | AS REQUIRED |
| 11. | Electrical Fuel Pump    | OFF         |

#### 4.5.3 Before Taxiing

- |    |                                 |   |
|----|---------------------------------|---|
| 1. | AVIONICS Switch                 | ON  |
| 2. | Avionics and Flight Instruments | SET UP                                    |
| 3. | Engine Instruments              | CHECK                                     |
| 4. | Voltmeter                       | CHECK if needle is within the green range |

|                |
|----------------|
| <b>CAUTION</b> |
|----------------|

Warm up the engine for approx. 2 min at 820 RPM and then at 1030 RPM until the Oil Temperature reaches 50°C (latter can be done during taxiing).

#### 4.5.4 Taxiing

- |    |                                  |                                      |
|----|----------------------------------|--------------------------------------|
| 1. | Parking Brake                    | RELEASE                              |
| 2. | Nose Wheel Steering              | CHECK function and for free movement |
| 3. | Brakes                           | CHECK                                |
| 4. | Flight Instruments and Avionics  | CHECK                                |
| 5. | Compass Reading/Gyro Instruments | CHECK                                |

| <i>Dokument No.:</i> | <i>Issue:</i> | <i>Supersedes Issue:</i> | <i>Date:</i> | <i>Page:</i> |
|----------------------|---------------|--------------------------|--------------|--------------|
| FM-AT01-1010-100E    | A.18          | A.12 (17/09/2008)        | 29/11/2010   | 4 - 14       |

|                |
|----------------|
| <b>CAUTION</b> |
|----------------|

Do not operate the engine at high RPM when taxiing over ground to prevent stone chipping or other damages by foreign objects or splashed water.

#### 4.5.5 Before Take-off (at the Taxi Holding Position)

- |     |                             |   |
|-----|-----------------------------|---|
| 1.  | Brakes                      | APPLY   |
| 2.  | Parking Brake               | SET   |
| 3.  | Fuel Selector Valve         | SWITCH to fullest tank  |
| 4.  | Fuel Pressure Warning Light | OFF ( <u>otherwise abort flight</u> )   |
| 5.  | Throttle                    | SET 1700 RPM.   |
| 6.  | Propeller Control Lever     | SWITCH 3 times b/w HIGH- and LOW-RPM Positions (end stops)<br>CHECK RPM drop: 200±50 RPM.<br><u>Thereafter:</u> SET HIGH-RPM Pos.<br>SET 1700 RPM.                                  |
| 7.  | Throttle                    | Magneto-check: SWITCH through: "L-BOTH-R-BOTH" – Positions.<br>CHECK RPM-drop<br>(Max. RPM-drop: 120;<br>max. difference L/R: 50,<br>min. difference: the drop must be noticeable). |
| 8.  | Ignition Switch             | <u>Thereafter:</u> SWITCH to BOTH.<br>ON<br>RPM-drop: in the range of 20 to 50 RPM  |
| 9.  | Carburettor Heat            | OFF   |
| 10. | Carburettor Heat            | IDLE  |
| 11. | Throttle                    | ON  |
| 12. | Electrical Fuel Pump        | TAKE-OFF Position   |
| 13. | Flaps                       | TAKE-OFF Position   |
| 14. | Trim                        | CHECK if within the green Range   |
| 15. | Engine Instruments          | CHECK if all pushed in  |
| 16. | Circuit breakers            | CHECK for free movement   |
| 17. | Control Stick               | FASTENED and TIGHTENED  |
| 18. | Seat Belts and Harnesses    | CLOSED and LATCHED  |
| 19. | Canopy                      | CHECK if canopy locking can release due to vibrations.  |
| 20. | Parking Brake               | RELEASE   |

| <i>Dokument No.:</i> | <i>Issue:</i> | <i>Supersedes Issue:</i> | <i>Date:</i> | <i>Page:</i> |
|----------------------|---------------|--------------------------|--------------|--------------|
| FM-AT01-1010-100E    | A.18          | A.12 (17/09/2008)        | 29/11/2010   | 4 - 15       |



**4.5.6 Take-off**

- |    |                  |                                |
|----|------------------|--------------------------------|
| 1. | Throttle         | FULL OPEN                      |
| 2. | Tachometer       | CHECK if within 2200-2260 RPM  |
| 3. | Elevator Control | NEUTRAL at initial ground roll |
| 4. | Rudder Pedals    | HOLD Direction                 |
| 5. | Lift Nose Wheel  | 50 KIAS                        |
| 6. | Climb Speed      | 65 KIAS                        |

**CAUTION**

For the shortest take-off distance over a 50-foot obstacle:

- |    |                 |         |
|----|-----------------|---------|
| 7. | Lift Nose Wheel | 50 KIAS |
| 8. | Climb Speed     | 57 KIAS |

**4.5.7 Climb**

- |    |                         |                 |
|----|-------------------------|-----------------|
| 1. | Propeller Control Lever | SET 2260 RPM    |
| 2. | Throttle                | OPEN            |
| 3. | Engine Instruments      | CHECK           |
| 4. | Flaps                   | CRUISE Position |
| 5. | Climb                   | at 65 KIAS      |
| 6. | Electrical Fuel Pump    | OFF             |
| 7. | Trim                    | SET as required |

**NOTE**

The Best Rate-of-Climb Speed  $V_Y$  is a function of the operating mass and decreases with increasing altitude. For more information, refer to Section 5.2.6.

| <i>Dokument No.:</i> | <i>Issue:</i> | <i>Supersedes Issue:</i> | <i>Date:</i> | <i>Page:</i> |
|----------------------|---------------|--------------------------|--------------|--------------|
| FM-AT01-1010-100E    | A.18          | A.12 (17/09/2008)        | 29/11/2010   | 4 - 16       |

#### 4.5.8 Cruise

- |    |                         |                                 |
|----|-------------------------|---------------------------------|
| 1. | Throttle                | AS REQUIRED (Ref. to Section 5) |
| 2. | Propeller Control Lever | SET between 1650 - 2260 RPM     |

|             |
|-------------|
| <b>NOTE</b> |
|-------------|

For favourable manifold pressure/propeller speed combinations: Refer to Section 5.

- |    |                    |                 |
|----|--------------------|-----------------|
| 3. | Flaps              | CRUISE Position |
| 4. | Trim               | AS REQUIRED     |
| 5. | Engine Instruments | CHECK           |

|                |
|----------------|
| <b>CAUTION</b> |
|----------------|

In flights above pressure altitudes of 6000 ft pay attention to the status of the fuel pressure warning light. If the Fuel Pressure Warning Light is illuminating, the electrical fuel pump has to be switched ON to prevent fuel vapour formation in the fuel system.

#### 4.5.9 Descent

- |    |                         |                             |
|----|-------------------------|-----------------------------|
| 1. | Throttle                | As Required                 |
| 2. | Propeller Control Lever | SET between 1800 - 2200 RPM |
| 3. | Carburettor Heat        | AS REQUIRED                 |

|                |
|----------------|
| <b>CAUTION</b> |
|----------------|

For a rapid descent proceed as follows:

- |                               |                 |
|-------------------------------|-----------------|
| Propeller Control Lever       | SET 2260 RPM    |
| Throttle                      | IDLE            |
| Carburettor Heat              | ON              |
| Flaps                         | CRUISE Position |
| Airspeed                      | 130 KIAS        |
| Oil/Cylinder Head Temperature | CHECK           |

#### 4.5.10 Landing

- |    |                          |                |
|----|--------------------------|----------------|
| 1. | Seat Belts and Harnesses | CHECK if TIGHT |
| 2. | Electrical Fuel Pump     | ON             |
| 3. | Carburettor Heat         | ON             |
| 4. | Throttle                 | AS REQUIRED    |
| 5  | Airspeed                 | 90 KIAS        |

| <i>Dokument No.:</i> | <i>Issue:</i> | <i>Supersedes Issue:</i> | <i>Date:</i> | <i>Page:</i> |
|----------------------|---------------|--------------------------|--------------|--------------|
| FM-AT01-1010-100E    | A.18          | A.12 (17/09/2008)        | 29/11/2010   | 4 - 17       |

- |     |                         |                              |
|-----|-------------------------|------------------------------|
| 6.  | Flaps                   | TAKE-OFF or LANDING Position |
| 7.  | Trim                    | AS REQUIRED                  |
| 8.  | Flaps                   | LANDING Position             |
| 9.  | Approach Speed          | 60 KIAS                      |
| 10. | Propeller Control Lever | HIGH-RPM Position            |
| 11. | Landing Light           | ON (as required)             |

|                |
|----------------|
| <b>CAUTION</b> |
|----------------|

The approach speed has to be adapted to the actual environmental conditions. With strong head or crosswinds as well as in turbulent air or with wind shears, it may be desirable to approach at appropriate higher than normal speeds.

#### 4.5.11 Balked Landing

- |    |                         |                   |
|----|-------------------------|-------------------|
| 1. | Throttle                | OPEN              |
| 2. | Propeller Control Lever | HIGH-RPM Position |
| 3. | Carburettor Heat        | OFF               |
| 4. | Flaps                   | TAKE-OFF Position |
| 5. | Airspeed                | 65 KIAS           |

#### 4.5.12 After Landing

- |    |                      |                 |
|----|----------------------|-----------------|
| 1. | Throttle             | IDLE            |
| 2. | Flaps                | CRUISE Position |
| 3. | Carburettor Heat     | OFF             |
| 4. | Electrical Fuel Pump | OFF             |
| 5. | Transponder          | OFF             |
| 6. | Landing Light        | OFF             |

#### 4.5.13 Engine Shutdown

- |     |                            |                              |
|-----|----------------------------|------------------------------|
| 1.  | Throttle                   | IDLE                         |
| 2.  | Parking Brake              | SET                          |
| 3.  | Flaps                      | LANDING Position             |
| 4.  | ELT                        | CHECK on frequency 121.5 MHz |
| 5.  | AVIONICS Switch            | OFF                          |
| 6.  | Ignition Switch            | OFF                          |
| 7.  | Electrical Equipment       | OFF                          |
| 8.  | Instrument Light           | OFF                          |
| 9.  | BAT-Switch                 | OFF                          |
| 10. | Brake Chocks and Tie-Downs | AS REQUIRED                  |

| <i>Dokument No.:</i> | <i>Issue:</i> | <i>Supersedes Issue:</i> | <i>Date:</i> | <i>Page:</i> |
|----------------------|---------------|--------------------------|--------------|--------------|
| FM-AT01-1010-100E    | A.18          | A.12 (17/09/2008)        | 29/11/2010   | 4 - 18       |

**4.5.14 Flight in Heavy Rain and/or with Strongly Soiled Wings****CAUTION**

Wet as well as strongly dirtied wings and control surfaces may impair the flight performance. This applies in particular to the take-off distance, climb performance and the maximum cruising speed.

An increase of the specified stall speeds of up to 3.0 kts may occur.  
Wet and dirt on the pitot-static-tube may lead to false airspeed and/or altitude indications.

The visibility may be significantly deteriorated due to rain and other precipitations.

| <i>Dokument No.:</i> | <i>Issue:</i> | <i>Supersedes Issue:</i> | <i>Date:</i> | <i>Page:</i> |
|----------------------|---------------|--------------------------|--------------|--------------|
| FM-AT01-1010-100E    | A.18          | A.12 (17/09/2008)        | 29/11/2010   | 4 - 19       |

**[Intentionally left blank]**

| <i>Dokument No.:</i> | <i>Issue:</i> | <i>Supersedes Issue:</i> | <i>Date:</i> | <i>Page:</i> |
|----------------------|---------------|--------------------------|--------------|--------------|
| FM-AT01-1010-100E    | A.18          | A.12 (17/09/2008)        | 29/11/2010   | 4 - 20       |

## SECTION 5 PERFORMANCE

|        |  | Page |
|--------|--|------|
| 5.1    | INTRODUCTION                                 | 5-2  |
| 5.2    | PERFORMANCE CHARTS                           | 5-3  |
| 5.2.1  | Airspeed Calibration                         | 5-3  |
| 5.2.2  | Stalling Speeds                              | 5-4  |
| 5.2.3  | Wind Components / Crosswind Components       | 5-5  |
| 5.2.4  | Flight Planning                              | 5-6  |
| 5.2.5  | Take-off Distance                            | 5-7  |
| 5.2.6  | Climb Performance / Cruise Altitude          | 5-8  |
| 5.2.7  | Climb: Fuel Consumption, Time and Distance   | 5-9  |
| 5.2.8  | Cruise Power Settings                        | 5-10 |
|        | Intentionally left blank                     | 5-11 |
| 5.2.9  | Cruise Performance (TAS – True Airspeed)     | 5-12 |
| 5.2.10 | Maximum Endurance                            | 5-13 |
| 5.2.11 | Maximum Range                                | 5-14 |
| 5.2.12 | Climb Performance after Balked Landing       | 5-15 |
| 5.2.13 | Landing Distance                             | 5-16 |
| 5.2.14 | Descent: Fuel Consumption, Time and Distance | 5-17 |
| 5.2.15 | Flight Planning Example                      | 5-18 |
| 5.2.16 | Noise Characteristics                        | 5-23 |

| <i>Document No.:</i> | <i>Issue:</i> | <i>Supersedes Issue:</i> | <i>Date:</i> | <i>Page:</i> |
|----------------------|---------------|--------------------------|--------------|--------------|
| FM-AT01-1010-100E    | A.12          | A.03 (15/04/2003)        | 17/09/2008   | 5 - 1        |

## 5.1 INTRODUCTION

The performance data in the following charts give an overview on the performance and capabilities of the AQUILA AT01. The information given herein provides a basis for the flight planning prior to every flight.

All data in the charts has been acquired during flight testing conducted with an aircraft and engine in a good operating condition and then corrected to ISA conditions (15°C and 1013.25 hPa at sea level).

The presented data is achieved with a well maintained aircraft and with average piloting techniques. All procedures specified in this manual were followed precisely.

The specified fuel flow data for cruise is based on the recommended RPM/Manifold pressure setting for each altitude. However, fuel flow and in result endurance with and without reserve is strongly dependent on the engine condition, the surface quality of the aircraft (clean, dry and no dirt residues) and meteorological conditions.

For a precise flight planning and to estimate the fuel required for the particular flight, all available information should be used and all influencing factors should be considered.

| <i>Document No.:</i> | <i>Issue:</i> | <i>Supersedes Issue:</i> | <i>Date:</i> | <i>Page:</i> |
|----------------------|---------------|--------------------------|--------------|--------------|
| FM-AT01-1010-100E    | A.12          | A.03 (15/04/2003)        | 17/09/2008   | 5 - 2        |

## 5.2 PERFORMANCE CHARTS

### 5.2.1 Airspeed Calibration

The airspeed calibration accounts for the position error of the pitot-static pressure system but not for the instrument error.

Assumption: Zero Instrument Error

Example: 120 KIAS (Indicated Airspeed) corresponds to 118 KCAS (Calibrated Airspeed)

**AQUILA AT01 Airspeed Calibration**

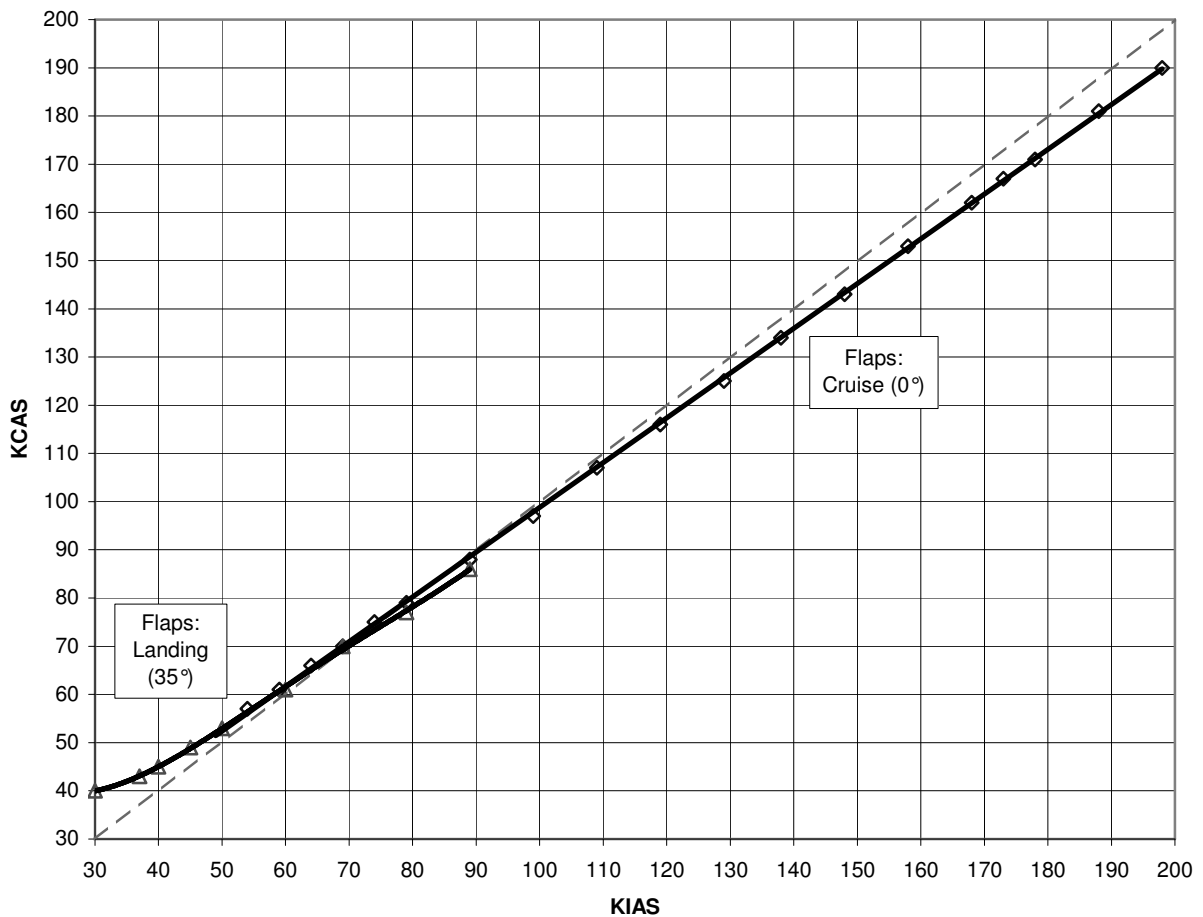

Fig.: 5.2.1 Airspeed Calibration

| Document No.:     | Issue: | Supersedes Issue: | Date:      | Page: |
|-------------------|--------|-------------------|------------|-------|
| FM-AT01-1010-100E | A.12   | A.03 (15/04/2003) | 17/09/2008 | 5 - 3 |



### 5.2.2 Stalling Speeds

Airplane flight configuration in which the stalling speeds were determined:

- Centre of Gravity (CG) Position: 31% MAC
- Take-off Mass: 750 kg

| <b>Power Setting</b> | <b>Flap Position</b> | <b>V<sub>s</sub></b> | <b>V<sub>s</sub></b> |
|----------------------|----------------------|----------------------|----------------------|
| <b>[%]</b>           | <b>Position</b>      | <b>[KCAS]</b>        | <b>[KIAS]</b>        |
| 75                   | Cruise               | 46                   | 40                   |
| 75                   | Take-off             | 42                   | 34                   |
| 75                   | Landing              | 40                   | 31                   |
| IDLE                 | Cruise               | 52                   | 43                   |
| IDLE                 | Take-off             | 47                   | 40                   |
| IDLE                 | Landing              | 43                   | 38                   |

Tab.: 5.2.2 Stalling Speeds in Straight-and-Level Flight

| <i>Document No.:</i> | <i>Issue:</i> | <i>Supersedes Issue:</i> | <i>Date:</i> | <i>Page:</i> |
|----------------------|---------------|--------------------------|--------------|--------------|
| FM-AT01-1010-100E    | A.12          | A.03 (15/04/2003)        | 17/09/2008   | 5 - 4        |

**5.2.3 Wind Components / Crosswind Components**

Maximum demonstrated crosswind component: 27 km/h, 15 Knots

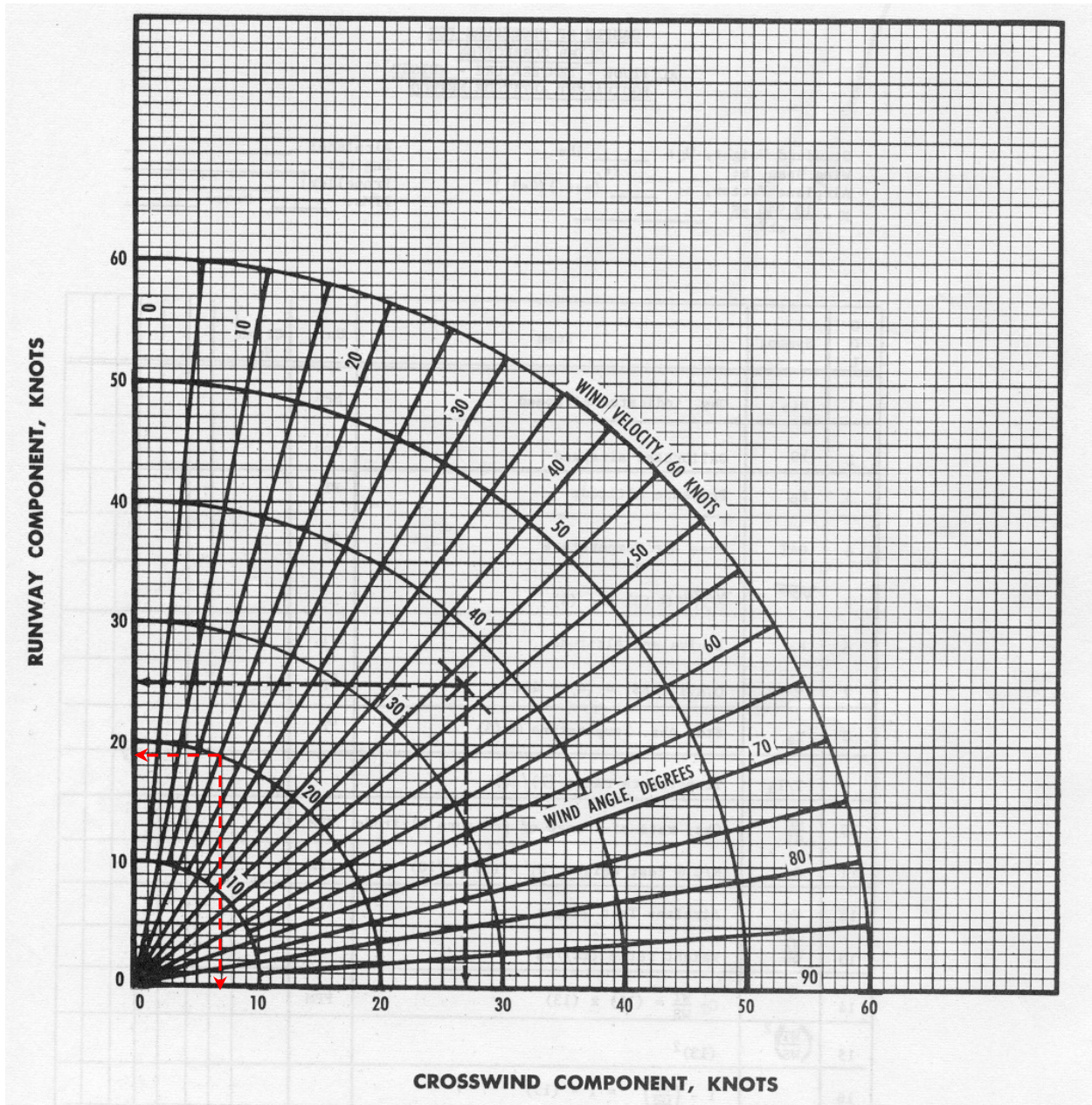

Example:

Reported Wind: 250  $\pm$  20 kts

RWY Direction: 270° (RWY 27) → differential angle RWY-Wind = 20°

⇒ Head Wind Component: 19 kts; Crosswind Component: 7 kts from the left side

| Document No.:     | Issue: | Supersedes Issue: | Date:      | Page: |
|-------------------|--------|-------------------|------------|-------|
| FM-AT01-1010-100E | A.12   | A.03 (15/04/2003) | 17/09/2008 | 5 - 5 |

### 5.2.4 Flight Planning

The performance tables and diagrams on the following pages contain all information necessary for the flight planning starting with the take-off planning at the departure airfield up to the point of determination of the estimated landing distance at the destination airfield.

Experience shows that there is a good match between the data determined in the flight planning and the actually flown data. However, the basic prerequisite for a good data correlation is a thorough planning in combination with a well maintained aircraft and an engine in a good operating condition as well as a sufficient experience of the pilot.

For the flight planning, it is recommended to determine always the values in a way to be on the safe side when reading out data or rounding values. In this way, possible differences in the actual performance data of the aircraft "at hand" from the specified data, acquired with the test aircraft in a defined operating condition, as well as other influences like unexpected turbulences can be accounted for. Those factors may cause differences in range, endurance and flight duration of up to 10%.

|             |
|-------------|
| <b>NOTE</b> |
|-------------|

Insects or other dirt on the propeller, the leading edge of the wing and other aerodynamic sensible areas can significantly reduce the performance and the handling qualities of the aircraft.

The influence of altitude and ambient air temperature has to be determined as follows:

1. Set the reference pressure on the altimeter to 1013 hPa to determine the actual pressure altitude.
2. The influence of the density altitude is accounted for by entering the corresponding diagrams with the ambient air temperature.

|                |
|----------------|
| <b>CAUTION</b> |
|----------------|

After the determination of the pressure altitude reset the altimeter setting to the local QNH before starting the planned flight. On ground, the altimeter should indicate the elevation of the airfield with this altimeter setting.

| <i>Document No.:</i> | <i>Issue:</i> | <i>Supersedes Issue:</i> | <i>Date:</i> | <i>Page:</i> |
|----------------------|---------------|--------------------------|--------------|--------------|
| FM-AT01-1010-100E    | A.12          | A.03 (15/04/2003)        | 17/09/2008   | 5 - 6        |

**5.2.5 Take-off Distance**

| Take-off Mass [kg] | KIAS     |          |
|--------------------|----------|----------|
|                    | Lift-off | at 50 ft |
| 750                | 50       | 57       |
| 600                | 50       | 55       |

**Conditions:**

Power Setting: Full Power  
 RPM: 2260 1/min  
 Flaps: 17° (T/O-Position)  
 Paved, level and dry runway.

**NOTES:**

- For operation on dry grass runway increase the required take-off distances by 25%, on soft grass runway by up to 40%.
- Add appropriate values for wet grass/ground, ice, snow and slush.
- In high humidity conditions the take-off distances may increase up to 10%.
- A not properly maintained aircraft, deviations from defined procedures, bad meteorological, ambient and runway conditions (rain, crosswind, wind shear, etc.) may considerably increase the required take-off distances.

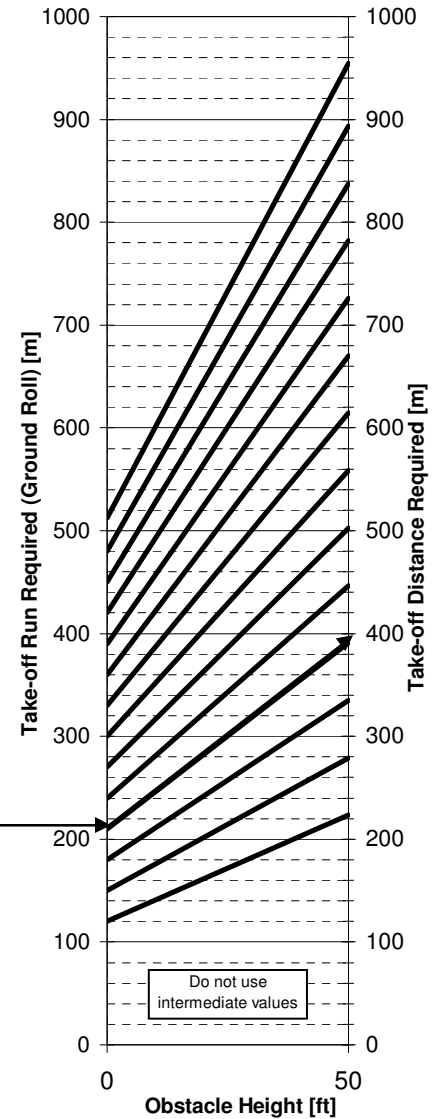
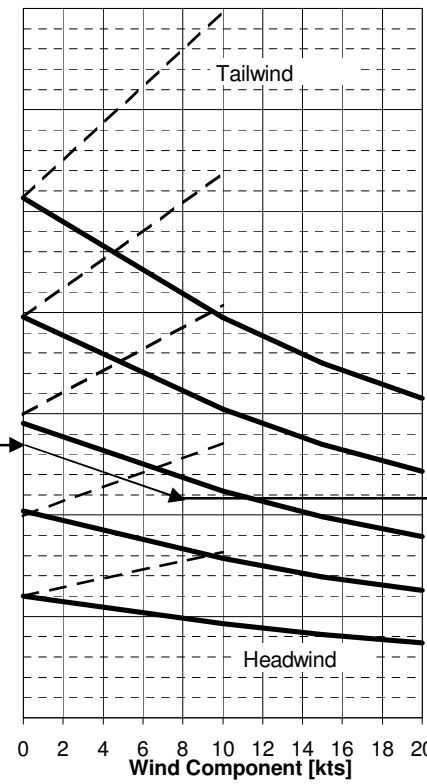
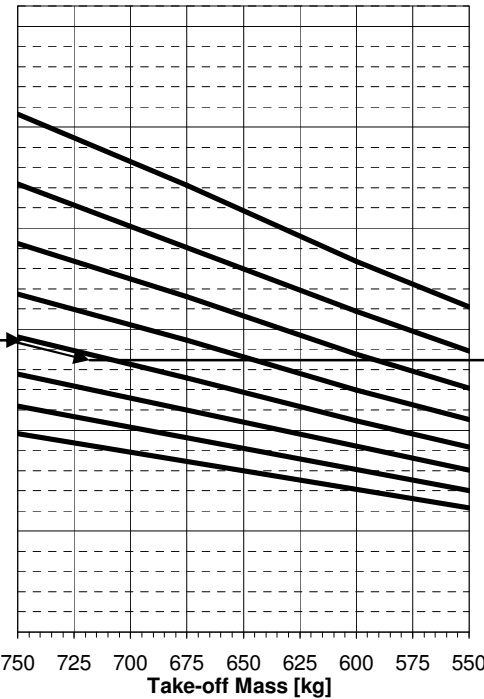
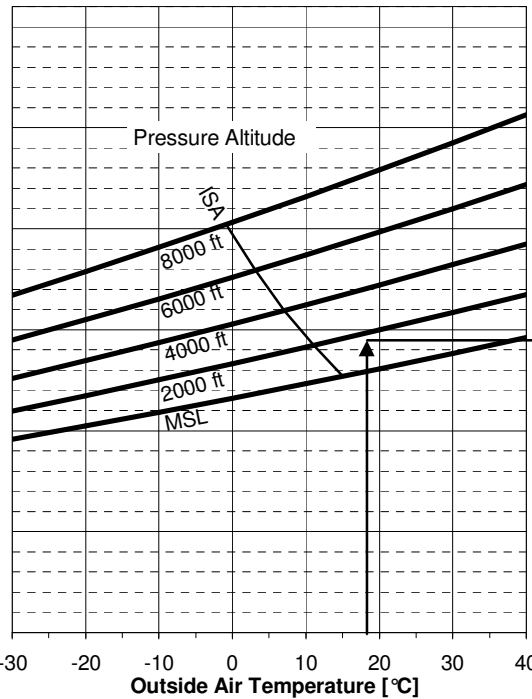

**Example:** Pressure Altitude: 1800 ft  
 Outside Air Temperature: 18°C

Take-off Mass: 720 kg

Headwind Component: 8 kts  
 Take-off Run Required (Ground Roll): 218 m

Take-off Distance Required: 400 m

| Document No.:     | Issue: | Supersedes Issue: | Date:      | Page: |
|-------------------|--------|-------------------|------------|-------|
| FM-AT01-1010-100E | A.12   | A.03 (15/04/2003) | 17/09/2008 | 5 - 7 |

**5.2.6 Climb Performance / Cruise Altitude**

| Take-off Mass [kg] |           | Best Rate-of-Climb Speed [KIAS] |          |           |
|--------------------|-----------|---------------------------------|----------|-----------|
|                    |           | MSL                             | 6 000 ft | 12 000 ft |
| 750                | 13 000 ft | 65                              | 63       | 61        |
| 600                | 16 000 ft | 62                              | 61       | 60        |

**Conditions:**  
 Throttle: Full Open  
 RPM: 2260 1/min  
 Flaps: Cruise (0°)

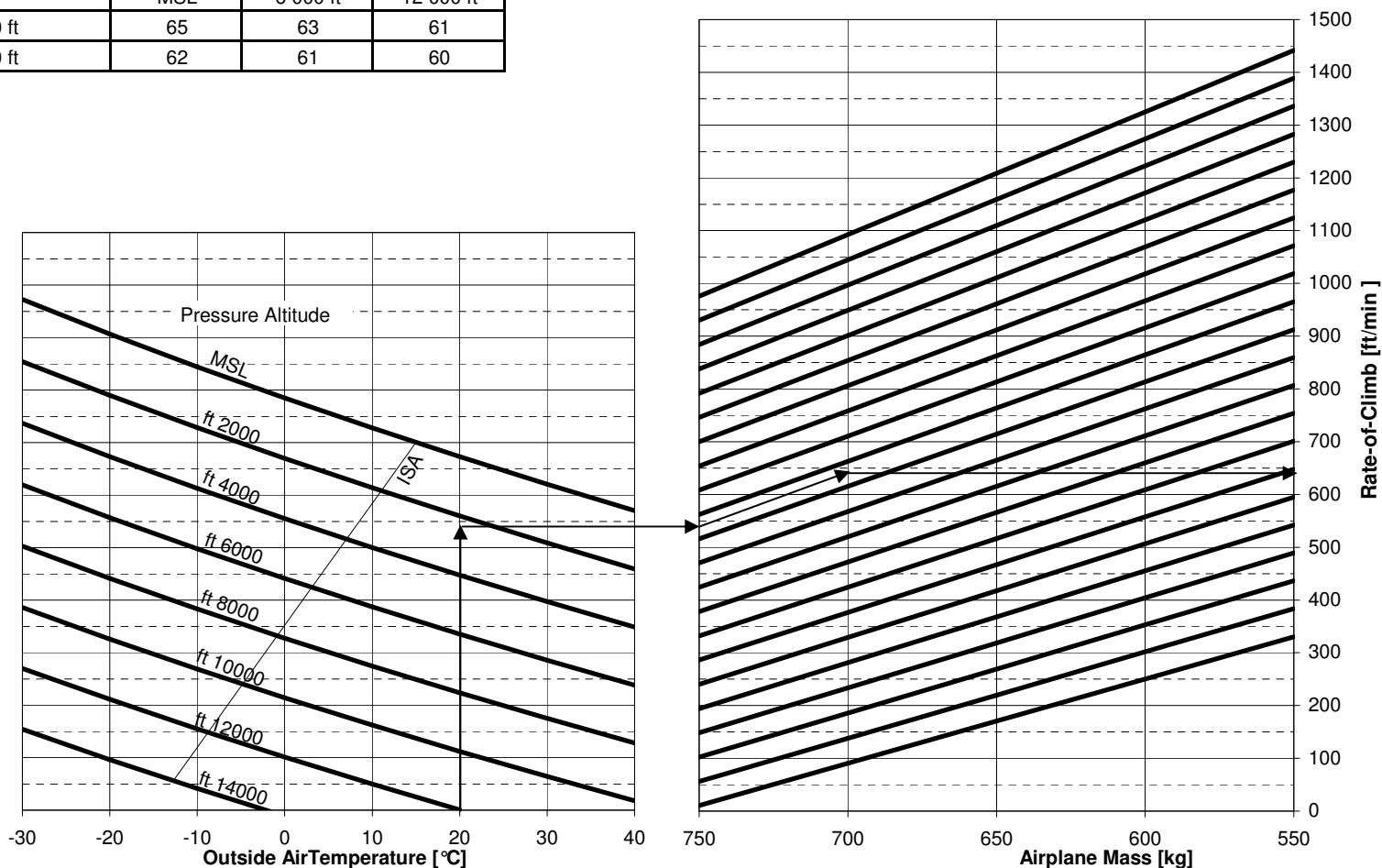

**Example:** Pressure Altitude: 2100 ft  
 Outside Air Temperature: +20°C

Airplane Mass: 700 kg

Rate-of-Climb: 640 ft/min

| Document No.:     | Issue: | Supersedes Issue: | Date:      | Page: |
|-------------------|--------|-------------------|------------|-------|
| FM-AT01-1010-100E | A.12   | A.03 (15/04/2003) | 17/09/2008 | 5 - 8 |

**5.2.7 Climb: Fuel Consumption, Time and Distance**

**Conditions:**

2260 1/min, Full Power, Vy= 65 KIAS until 5 000 ft  
 Flaps: Cruise (0°) Vy= 63 KIAS until 10 000 ft  
 m = 750 kg Vy= 61 KIAS until 13 000 ft  
 NO WIND

For each 8°C above ISA-Conditions:  
 Increase Time, Distance and Fuel  
 Consumption by 10 %.

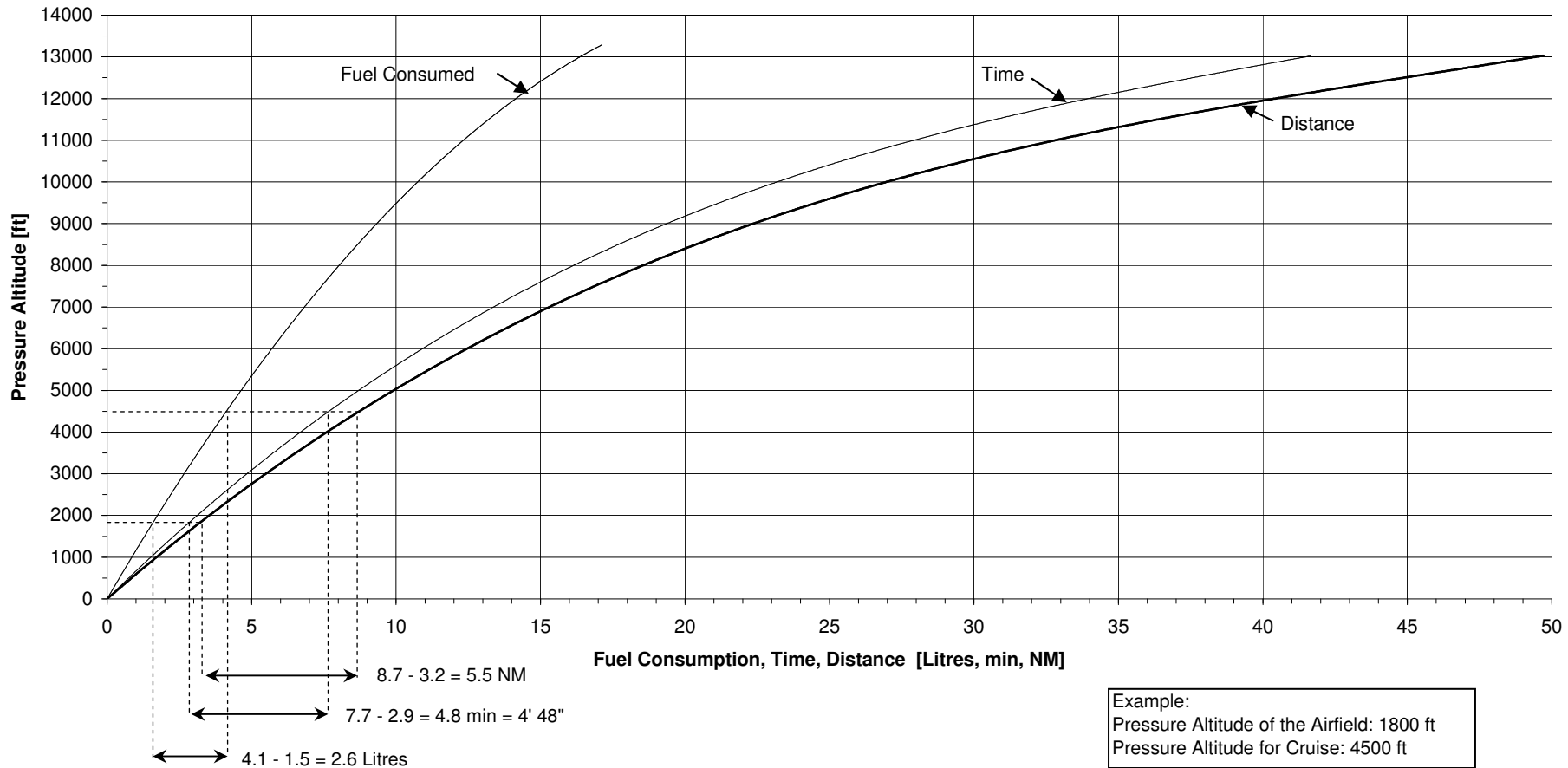

| Document No.:     | Issue: | Supersedes Issue: | Date:      | Page: |
|-------------------|--------|-------------------|------------|-------|
| FM-AT01-1010-100E | A.12   | A.03 (15/04/2003) | 17/09/2008 | 5 - 9 |

### 5.2.8 Cruise Power Settings

| Press.<br>Alt | Temp.<br>(ISA) | Cruise Power - % of the Maximum Continuous Power MCP |         |       |         |         |       |         |         |       |         |         |       |         |         |       |
|---------------|----------------|--|---------|-------|---------|---------|-------|---------|---------|-------|---------|---------|-------|---------|---------|-------|
|               |                | 55%  |         |       | 65%     |         |       | 75%     |         |       | 85%     |         |       | MCP     |         |       |
| T             | RPM            | MP   | F/F     | RPM   | MP      | F/F     | RPM   | MP      | F/F     | RPM   | MP      | F/F     | RPM   | MP      | F/F     |       |
| [ft]          | [°C]           | [1/min]  | [in Hg] | [l/h] | [1/min] | [in Hg] | [l/h] | [1/min] | [in Hg] | [l/h] | [1/min] | [in Hg] | [l/h] | [1/min] | [in Hg] | [l/h] |
| 0             | 15             | 1900   | 24.6    | 14    | 2000    | 25.7    | 15.6  | 2100    | 27.0    | 21.0  | 2260    | 27.7    | 24    | 2260    | 28      | 26    |
| 2,000         | 11             | 1900   | 24.0    | 15    | 2000    | 24.7    | 16.0  | 2200    | 25.7    | 21.3  | 2260    | 26.7    | 22    | 2260    | 27      | 26    |
| 4,000         | 7              | 1900   | 23.3    | 16    | 2100    | 23.3    | 16.8  | 2260    | 24.3    | 21.5  | 2260    | 25.2    | 22    |         |         |       |
| 6,000         | 3              | 2000   | 22.0    | 17    | 2200    | 22.7    | 19.3  | 2260    | 23.3    | 22.3  |         |         |       |         |         |       |
| 8,000         | -1             | 2100   | 21.0    | 18    | 2200    | 21.5    | 21.5  | 2260    | 21.5    | 23.0  |         |         |       |         |         |       |
| 10,000        | -5             | 2200   | 19.7    | 19    | 2260    | 20.1    | 22.0  |         |         |       |         |         |       |         |         |       |
| 12,000        | -9             | 2260   | 18.5    | 19    |         |         |       |         |         |       |         |         |       |         |         |       |

MCP: Maximum Continuous Power  
 RPM: Revolutions per Minute  
 MP: Manifold Pressure  
 F/F: Fuel Flow

#### Data Correction for non-ISA temperature conditions:

For each 10°C above ISA: increase Manifold Pressure by 3%,  
Fuel consumption will increase by 5%

For each 10°C below ISA: decrease Manifold Pressure by 3%,  
Fuel consumption will decrease by 5%

#### Example:

Flight Altitude: 2000 ft  
 ISA-Temperature: 11°C  
 Temperature in flight altitude: 21°C (ISA + 10°C)  
 Power Setting: 65%  
 RPM: 2000 1/min  
 Manifold pressure for ISA (see chart): 24.7 in Hg  
 Manifold pressure calculated for ISA + 10°C:  $24.7 + (0.247 \times 3.0) = 25.44$  in Hg  
 Fuel consumption for ISA: 16 l/h  
 Fuel consumption calculated for ISA + 10°C:  $16 + (0.16 \times 5.0) = 16.8$  l/h

| Document No.:     | Issue: | Supersedes Issue: | Date:      | Page:  |
|-------------------|--------|-------------------|------------|--------|
| FM-AT01-1010-100E | A.12   | A.03 (15/04/2003) | 17/09/2008 | 5 - 10 |

**[Intentionally left blank]**

| <i>Document No.:</i> | <i>Issue:</i> | <i>Supersedes Issue:</i> | <i>Date:</i> | <i>Page:</i> |
|----------------------|---------------|--------------------------|--------------|--------------|
| FM-AT01-1010-100E    | A.12          | A.03 (15/04/2003)        | 17/09/2008   | 5 - 11       |



**5.2.9 Cruise Performance (TAS – True Airspeed)**

**Conditions:**  
 Power Setting: Refer to table 5.2.8 on page 5-10.  
 Airplane Mass: 750 kg  
 Flaps: Cruise-Position (0°)

**NOTE:** Without wheel fairings, reduce the determined speeds by approximately 5 %.

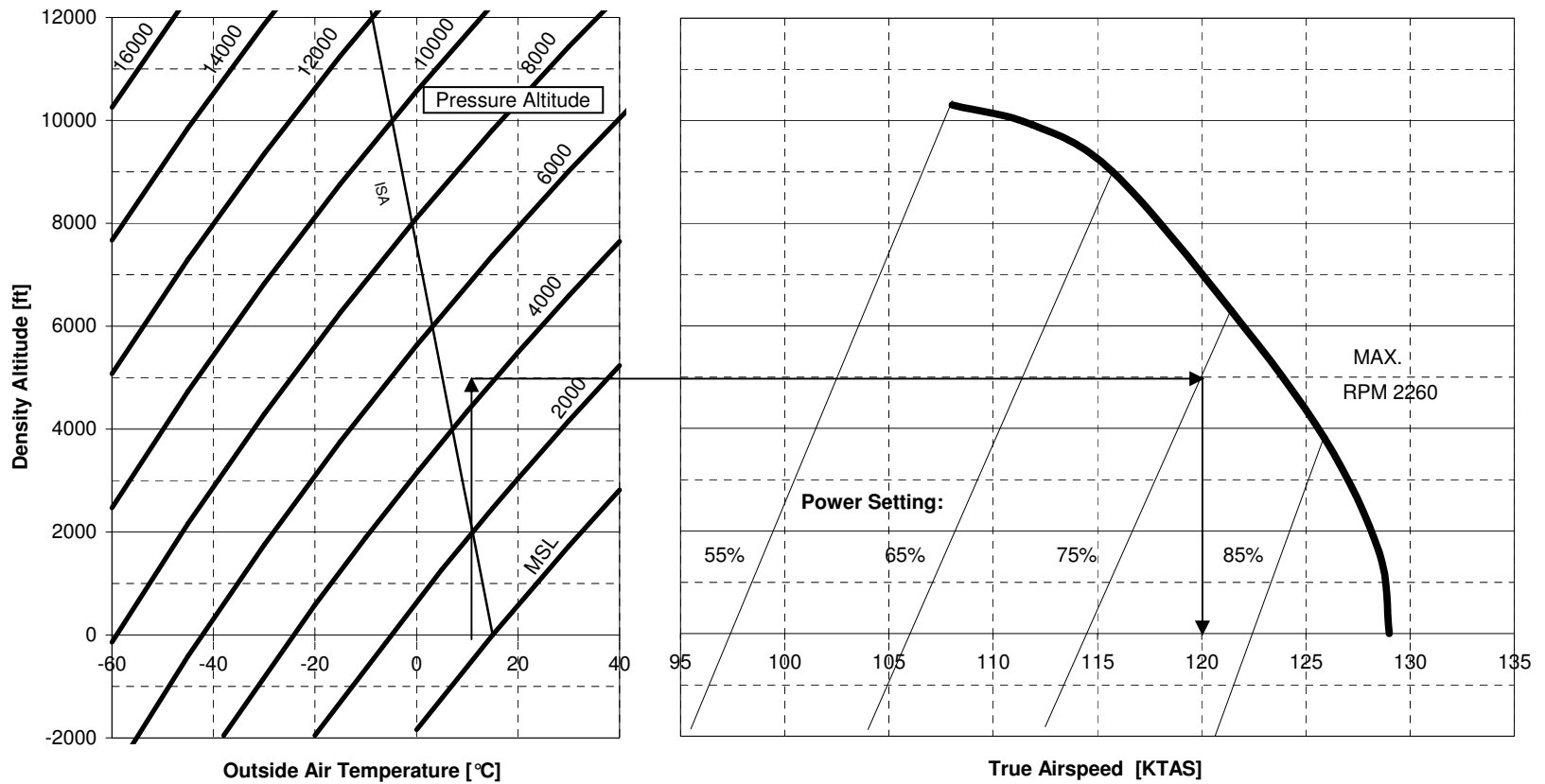

**Example:** Pressure Altitude: 4500 ft      Density Altitude: 5000 ft      Power Setting : 75%      True Airspeed: 120 kts  
 Outside Air Temperature: +10°C

| Document No.:     | Issue: | Supersedes Issue: | Date:      | Page:  |
|-------------------|--------|-------------------|------------|--------|
| FM-AT01-1010-100E | A.12   | A.03 (15/04/2003) | 17/09/2008 | 5 - 12 |

**5.2.10 Maximum Endurance**

**Condition:**

Power Setting: according table 5.2.8 on page 5-10  
Airplane Mass: 750 kg  
Flaps: Cruise-Position (0°)

**NOTE:**

A not properly maintained engine and aircraft may considerably deteriorate the endurance of the airplane.

**Fuel Quantities:** usable Fuel 109.6 Litres

The calculation of the endurance includes:

1. Fuel for Engine Start-up and Taxiing: 2 Litres.
2. Fuel for Take-off and Climb to Cruise Altitude with max. continuous power as well as fuel for the descent.
3. Reserve for 30 min. Holding Procedure at 55% = 7.5 Litres.

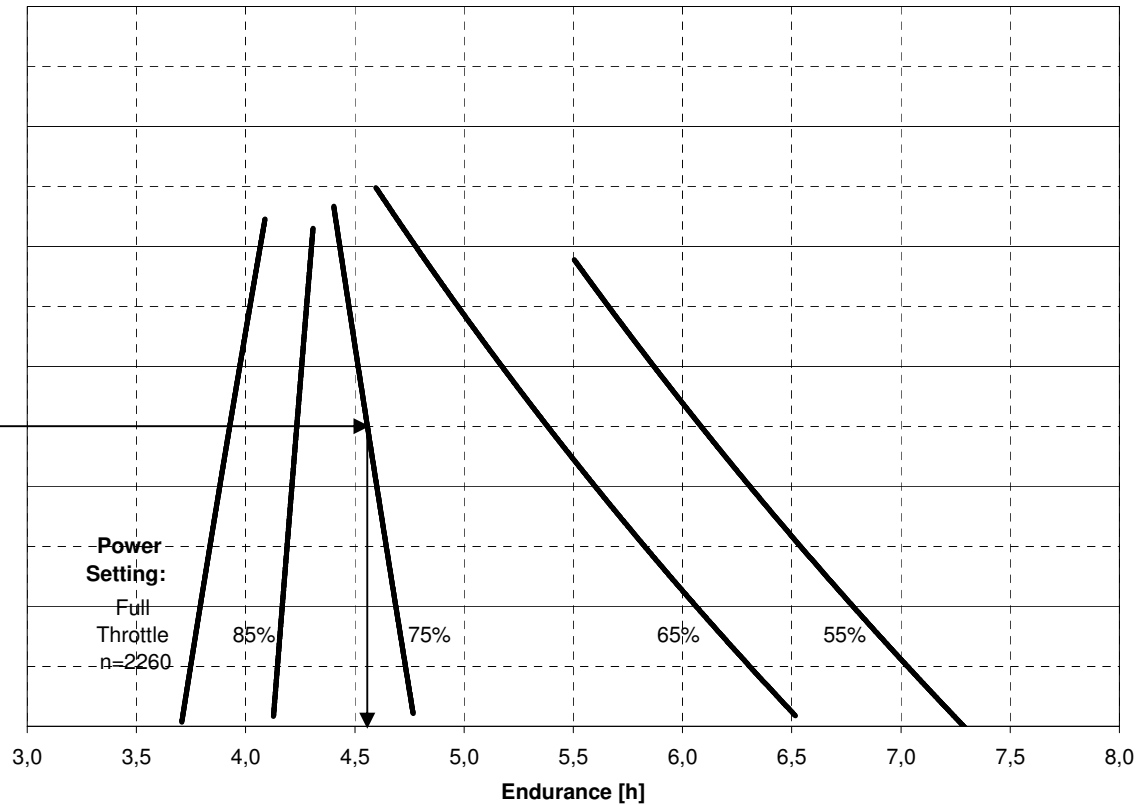
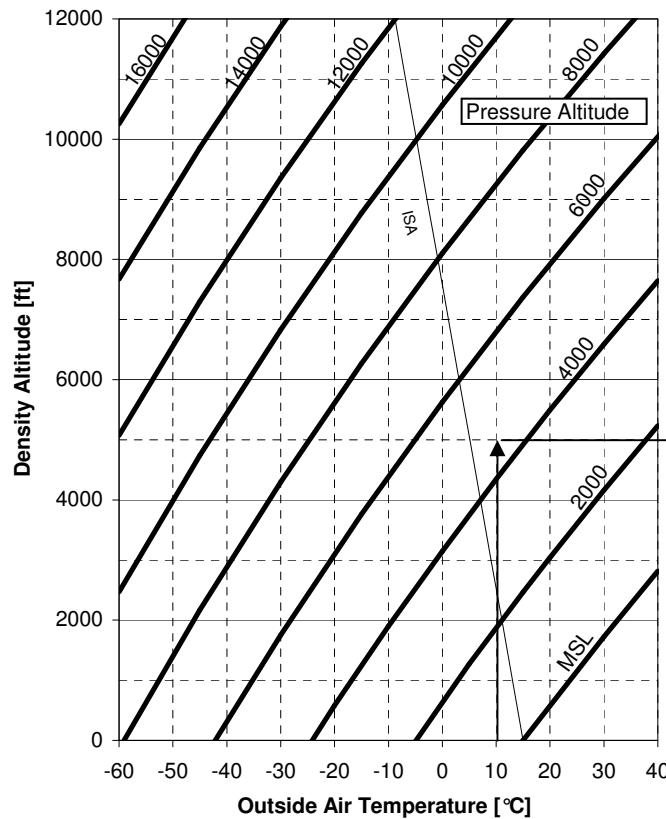

**Example:** Pressure Altitude 4500 ft  
Outside Air Temperature +10°C

Density Altitude: 5000 ft

Power Setting: 75%

Endurance: 4.55 h = 4 h 33'

| Document No.:     | Issue: | Supersedes Issue: | Date:      | Page:  |
|-------------------|--------|-------------------|------------|--------|
| FM-AT01-1010-100E | A.12   | A.03 (15/04/2003) | 17/09/2008 | 5 - 13 |

**5.2.11 Maximum Range**

**Conditions:**

Power Setting: according table 5.2.8 on page 5-10  
Airplane Mass: 750 kg  
Flaps: Cruise-Position (0°)

**NOTE:**

A not properly maintained engine and aircraft may considerably deteriorate the range of the airplane.

**Fuel Quantities:** usable Fuel: 109.6 Litres.

The calculation of the range includes:

1. Fuel for Engine Start-up and Taxiing: 2 Litres.
2. Fuel for Take-off and Climb to Cruise Altitude with max. continuous power as well as fuel for the descent.
3. Reserve for 30 min. Holding Procedure at 55% = 7.5 Litres.

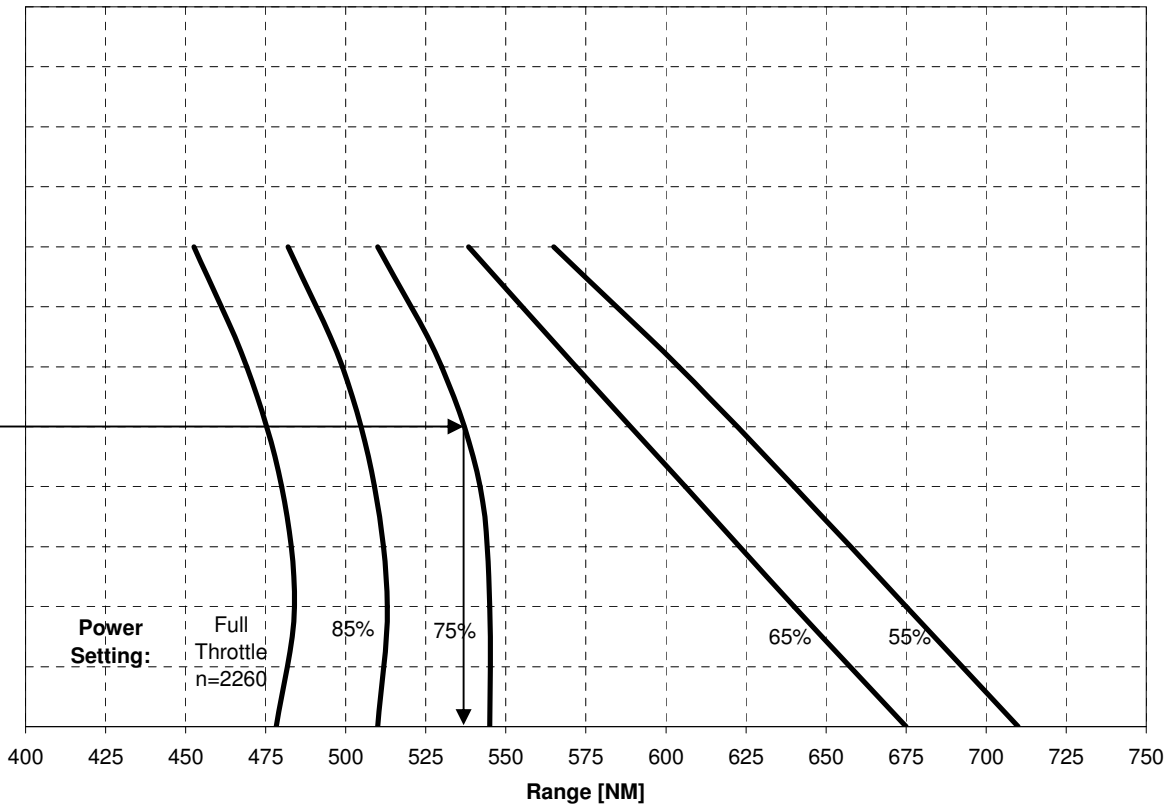
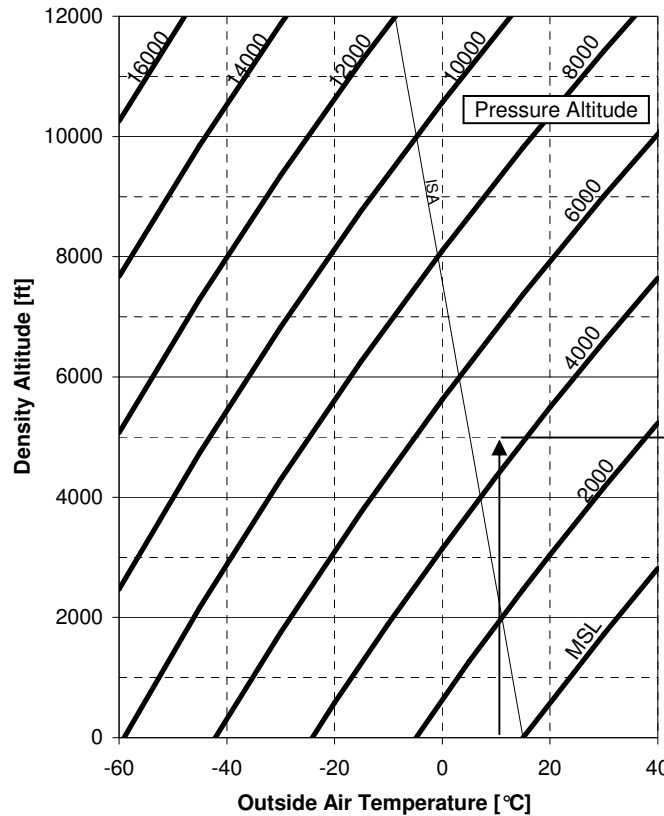

**Example:** Pressure Altitude 4500 ft  
Outside Air Temperature +10°C

Density Altitude: 5000 ft

Power Setting: 75%

Range: 537 NM

|                      |               |                          |              |              |
|----------------------|---------------|--------------------------|--------------|--------------|
| <i>Document No.:</i> | <i>Issue:</i> | <i>Supersedes Issue:</i> | <i>Date:</i> | <i>Page:</i> |
| FM-AT01-1010-100E    | A.12          | A.03 (15/04/2003)        | 17/09/2008   | 5 - 14       |

**5.2.12 Climb Performance after Balked Landing**

**Conditions:**  
 Power Setting: Full Power  
 RPM: 2260 1/min  
 Flaps: Landing Position (35°)  
 Climb Speed: 55 KIAS

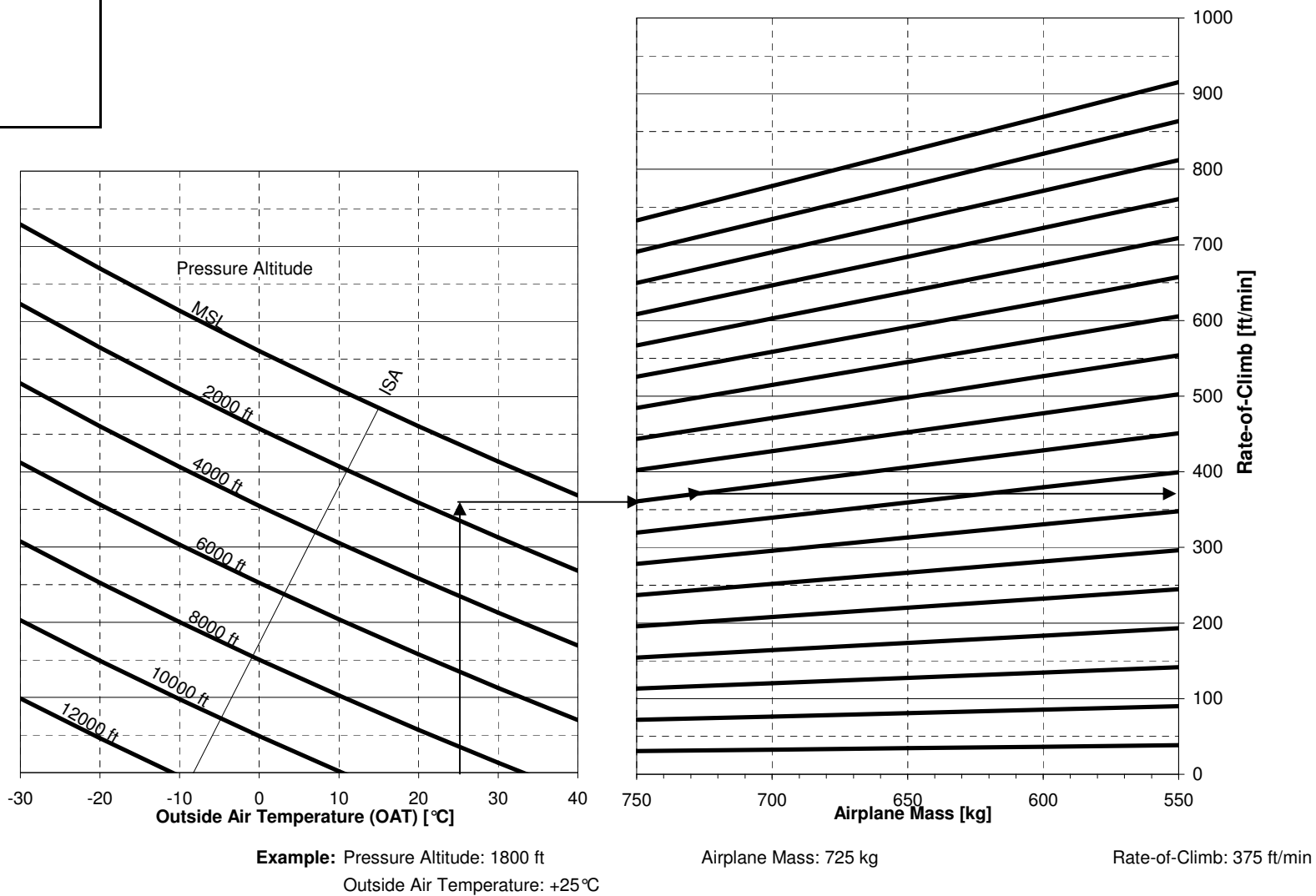

| Document No.:     | Issue: | Supersedes Issue: | Date:      | Page:  |
|-------------------|--------|-------------------|------------|--------|
| FM-AT01-1010-100E | A.12   | A.03 (15/04/2003) | 17/09/2008 | 5 - 15 |

**5.2.13 Landing Distance**

| Landing Mass [kg] | KIAS     | KIAS      |
|-------------------|----------|-----------|
|                   | at 50 ft | Touchdown |
| 750               | 65       | 45        |
| 600               | 65       | 43        |

**NOTES:**

- For landing on dry grass runway increase the required landing distances by 15%.
- Add appropriate values for wet grass/ground, ice, snow and slush.
- A not properly maintained aircraft, deviations from defined procedures, bad meteorological and runway conditions (rain, crosswind, windshear, etc.) may considerably increase the landing distances.

**Conditions:**  
 Power Setting: Idle  
 Propeller: Low Pitch (Propeller Control Lever: HIGH-RPM Position)  
 Flaps: Landing Position (35°)  
 Maximum brake application.  
 Paved, level and dry runway.

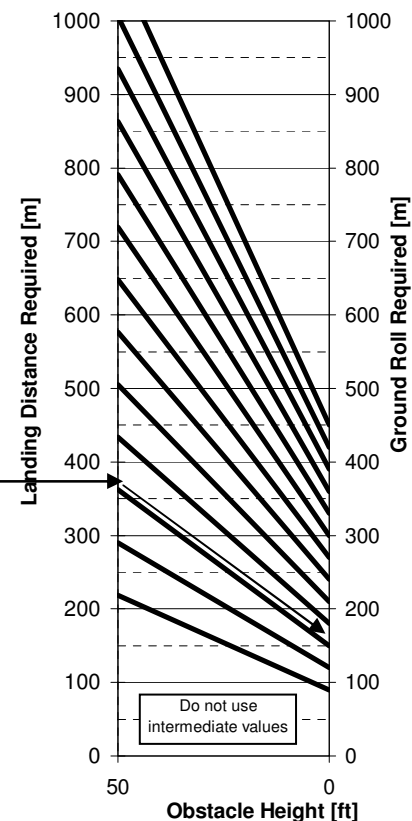
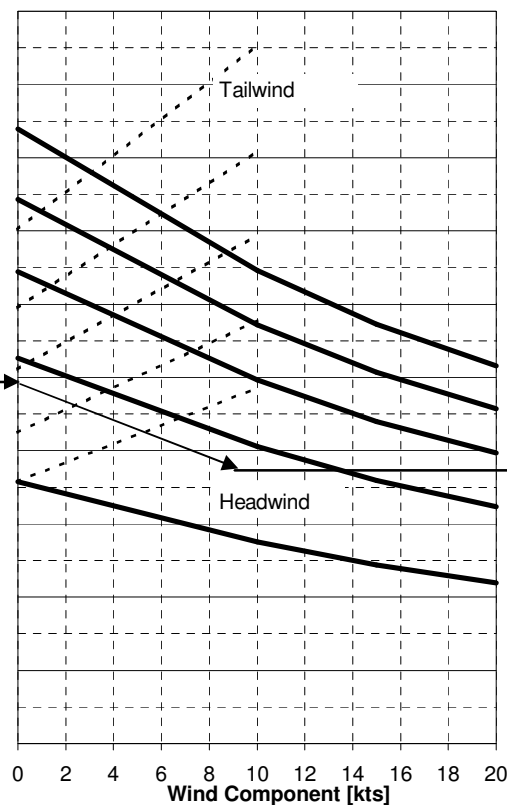
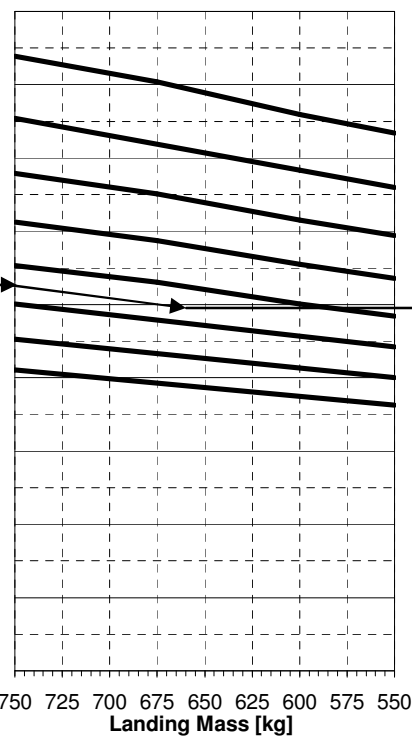
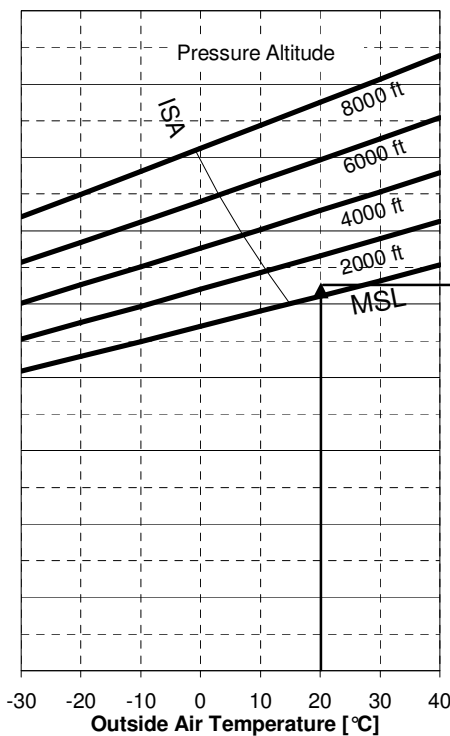

**Example:** Pressure Altitude: 380 ft      Landing Mass: 659 kg      Headwind Component: 9 kts      Landing Distance: 375 m      Ground Roll: 160 m  
 Outside Air Temperature 20°C

| Document No.:     | Issue: | Supersedes Issue: | Date:      | Page:  |
|-------------------|--------|-------------------|------------|--------|
| FM-AT01-1010-100E | A.12   | A.03 (15/04/2003) | 17/09/2008 | 5 - 16 |

**5.2.14 Descent: Fuel Consumption, Time and Distance**

**Procedure:**

During descent maintain Indicated Airspeed of 120 KIAS.  
Set engine power for a sink rate of 750 ft/min.  
Keep the Engine Temperatures within the green arc range.  
If necessary activate Carburettor Heating.

**Conditions:**

Manifold Pressure: as necessary. Approximately 15 in Hg  
RPM: 2 000 1/min  
Flaps: Cruise-Position (0°)

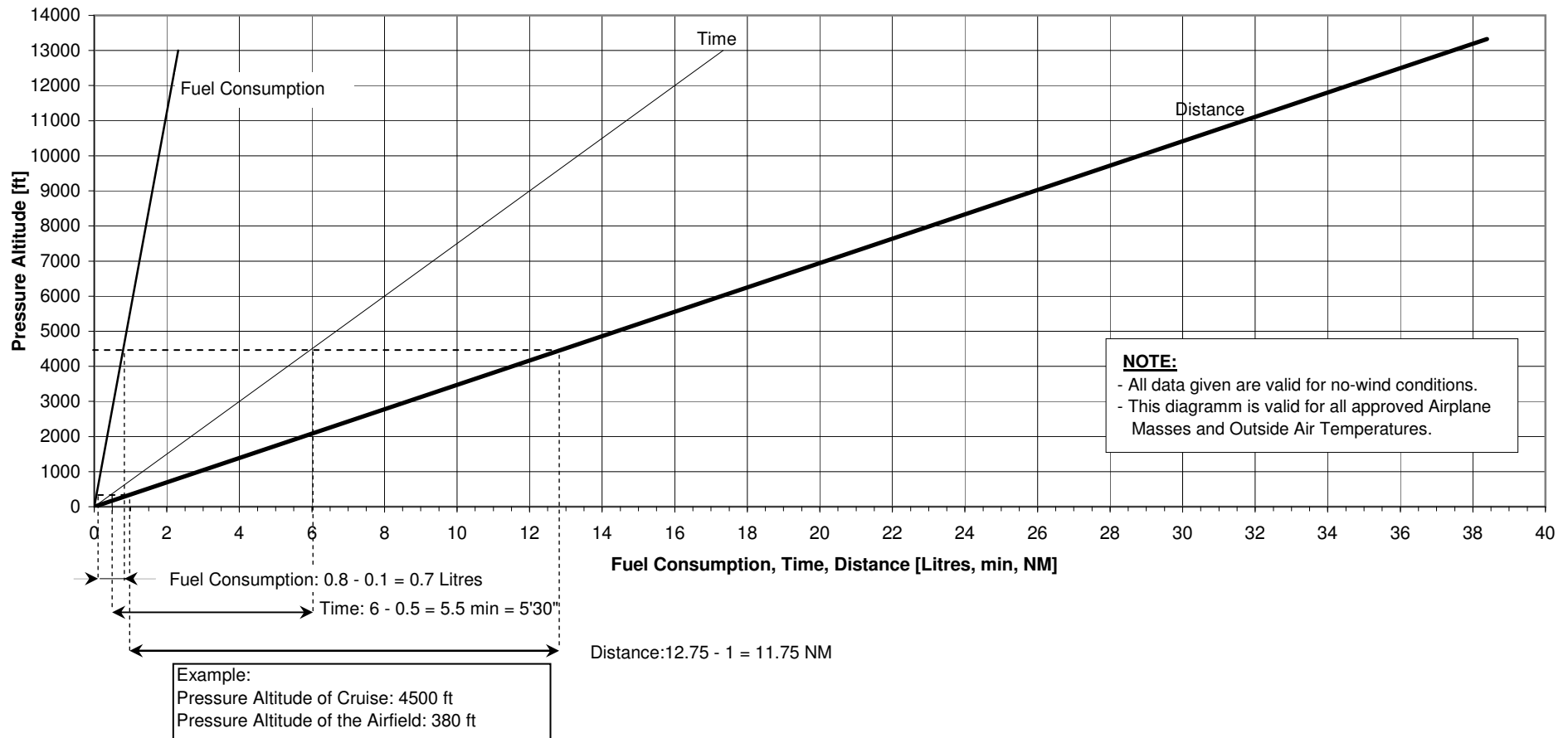

| Document No.:     | Issue: | Supersedes Issue: | Date:      | Page:  |
|-------------------|--------|-------------------|------------|--------|
| FM-AT01-1010-100E | A.12   | A.03 (15/04/2003) | 17/09/2008 | 5 - 17 |

### 5.2.15 Flight Planning Example

The following contains a flight planning example with the AQUILA AT01 to demonstrate the application and handling of the tables, charts and data presented in this section of the Flight Manual. The planning of the flight has been based upon the following boundary conditions:

#### **Aircraft**

Take-off mass:..... 720 kg  
Usable Fuel: ..... 109.6 litres  
Wheel Fairings installed

#### **Conditions at the departure airfield**

Pressure Altitude: ..... 1800 ft  
Temperature: ..... 18°C (ca. 7°C above ISA)  
RWY Direction: ..... 24 (240°)  
Wind Conditions ..... 280°/10 kts  
RWY Length (paved, level and dry RWY)..... 620 m

#### **Cruise Conditions**

Overall Flight Distance to Destination..... 480 NM (888 km)  
Cruise Altitude (Altimeter setting 1013 hPa) .. 4500 ft  
Temperature at Cruise Alt..... 10°C (4°C above ISA)  
Reported wind en-route ..... 10 kts Tailwind Component

#### **Conditions at the destination airfield**

Pressure Altitude ..... 380 ft  
Temperature ..... 20°C (6°C über ISA)  
RWY Direction ..... 27 (270°)  
Wind Conditions ..... 220°/15 kts  
RWY Length (dry and level grass RWY) ..... 780 m

### **TAKE-OFF RUN AND DISTANCE**

Before entering chart 5.2.5 on page 5-7 to determine the Take-off Run and Take-off Distance Required the headwind and crosswind component of the wind relative to the runway direction has to be obtained from chart 5.2.3 on page 5-5.

Relative to the runway direction the wind comes at an angle of 40° from the right with 10 kts. Entering chart 5.2.3 with these values we obtain a Headwind Component of 8 kts and a Crosswind Component of 7 kts. The Crosswind Component is within the approved range of 15 kts.

Now we have all the necessary data to determine the required Take-off distances from chart 5.2.5 and we obtain the following values for our example:

Take-off Run Required (Ground Roll): ..... 218 m  
Lift-off speed: ..... 50 KIAS  
Take-off Distance Required (incl. initial climb to a height of 50 ft)..... 400 m  
Airspeed at 50 ft height ..... 57 KIAS

The Take-off Distance Required is within the available runway length (TODA) of 620 m.

| <i>Document No.:</i> | <i>Issue:</i> | <i>Supersedes Issue:</i> | <i>Date:</i> | <i>Page:</i> |
|----------------------|---------------|--------------------------|--------------|--------------|
| FM-AT01-1010-100E    | A.12          | A.03 (15/04/2003)        | 17/09/2008   | 5 - 18       |

**CLIMB**

The climb performance, i.e. the achievable climb rate and the best rate-of-climb speed can be obtained from chart 5.2.6 on page 5-8. Entry parameters are the Take-off Mass, Pressure Altitude and Outside Air Temperature.

The determination of the time needed and distance covered as well as the fuel consumption for the climb segment has to be done with chart 5.2.7 on page 5-9.

In our example, the take-off occurs already at an altitude of 1800 ft. This means that we have to determine the values for the cruise altitude and for the altitude where the climb is initiated from chart 5.2.7. The values obtained for the initial climb altitude have to be subtracted from the values obtained for the cruise altitude.

Since the outside air temperature is 7°C above ISA the values determined from chart 5.2.7 are increased by 10%. For our example we obtain:

Climbing Time:.....(7.7 – 2.9) · 1.1 = 5.3 min = 5'20"  
 Climbing Distance:.....(8.7 NM – 3.2 NM) · 1.1 = 6 NM  
 Fuel needed:.....(4.1 Litres – 1.5 Litres) · 1.1 = 2.7 Litres

The reported tailwind component of 10 kts for the Cruise Altitude has also an effect on the climb segment and affects the climbing distance. It has no influence on the climbing time and the fuel consumption.

The wind speed and profile usually change with altitude. In our example we assume a constant tailwind component for the climb segment of 7 kts.

During the climb segment, the tailwind acts on the aircraft for 5.3 minutes. As a result, we obtain for the covered distance on ground during the climb segment:

$$6 \text{ NM} + \frac{7 \text{ kts} \cdot 5.3 \text{ min}}{60 \text{ min/h}} = 6.62 \text{ NM}$$

The result shows that the wind has only a marginal influence on the climbing distance and contributes noticeably only in the case of high head/tailwind components or climbs of long duration (i.e. with high altitude differences). In the present planning example the wind influence on the climbing distance could have rather been neglected.

**DESCENT**

The proceeding for determining the performance data for the descent flight segment is analogous to the climb segment. Chart 5.2.14 on page 5-17 provides the means to obtain the time, distance and fuel consumption for the descent segment. In our flight planning example, the descent is initiated at Cruise altitude (4500 ft) and ends at 380 ft. Again, we have to subtract the values of the descent endpoint from the values of the initial point. During the descent the altimeter setting has to be duly changed to the local QNH.

Descent duration:..... 6 min – 0.5 min = 5.5 min = 6'0" - 0'30" = 5' 30"  
 Descent distance:..... 12.75 NM – 1.0 NM = 11.75 NM  
 Fuel needed:..... 0.8 Litres – 0.1 Litres = 0.7 Litres

| <i>Document No.:</i> | <i>Issue:</i> | <i>Supersedes Issue:</i> | <i>Date:</i> | <i>Page:</i> |
|----------------------|---------------|--------------------------|--------------|--------------|
| FM-AT01-1010-100E    | A.12          | A.03 (15/04/2003)        | 17/09/2008   | 5 - 19       |



A correction for the tailwind influence and the temperature difference to ISA-conditions has not been included in our planning example. The influence is negligible in our case.

## **CRUISE**

The choice of the cruise altitude is usually a compromise considering the flight distance, aircraft performance, topography, airspace structure, en-route weather conditions and other influencing factors. In the present flight planning example, a typical cruise altitude and en-route wind condition has been chosen.

The range diagram in chart 5.2.11 on page 5-14 shows the relationship between engine power setting and maximum achievable range as a function of Pressure Altitude and Outside Air Temperature. Lower power settings result in considerable fuel savings and thus higher achievable ranges.

Applying chart 5.2.11 to our example, a chosen power setting of 75 % and a cruise altitude of 4500 ft yields a maximum range of 537 NM at a True Airspeed of 120 kts. The Cruise Speed in True Airspeed has been obtained from chart 5.2.9 on page 5-12 taking into account the atmospheric conditions (Outside Air Temperature and chosen Pressure Altitude for Cruise) and the chosen power setting as the entry parameters.

The maximum possible flight endurance is obtained by means of chart 5.2.10 on page 5-13. For our planning example the chart yields a maximum endurance of 4.55 hours at a power setting of 75 %. The determined maximum endurance and range contains a 30 minutes holding reserve, the engine start-up and taxiing as well as the flight segments take-off, climb, cruise, descent and landing.

Taking the reported tailwind of 10 kts in 4500 ft into consideration the maximum achievable range has to be corrected as follows:

|   |                 |
|---|-----------------|
| Range with no wind  | 537,0 NM        |
| Range increment due to 10 kts<br>tailwind (4,55 h x 10 kts) | 45,5 NM         |
|   | <u>582,5 NM</u> |

From this it follows that the planned flight over a distance of 480 NM with a cruise power setting of 75 % does not conflict with the aircraft performance and is feasible as a non-stop flight without an additional fuel stop.

| <i>Document No.:</i> | <i>Issue:</i> | <i>Supersedes Issue:</i> | <i>Date:</i> | <i>Page:</i> |
|----------------------|---------------|--------------------------|--------------|--------------|
| FM-AT01-1010-100E    | A.12          | A.03 (15/04/2003)        | 17/09/2008   | 5 - 20       |

**CALCULATION OF THE FUEL AMOUNT REQUIRED**

|   |                   |   |
|---|-------------------|---|
| Required fuel for engine start-up and taxiing | 2.0 Litres        | (see remark "Fuel Quantity" on chart 5.2.10 and 5.2.11) |
| Required fuel for climb (page 5-9)            | + 2.7 Litres      |   |
|   | <u>4.7 Litres</u> |   |
| Climb distance (page 5-9)                     | 6.0 NM            |   |
| Wind Correction (Tailwind)                    | + 0.6 NM          |   |
|   | <u>6.6 NM</u>     |   |

During the descent from 4500 ft to 380 ft a distance of 11.75 NM is covered and 0.7 Litres of fuel are consumed (chart 5.2.14). The influence of the wind has been neglected.

|                         |                 |
|-------------------------|-----------------|
| Overall flight distance | 480 NM          |
| Climb distance          | -6,6 NM         |
| Descent distance        | - 11,75 NM      |
| Cruise section:         | <u>461,7 NM</u> |

For the calculation of the time required to cover the cruising distance of 461.7 NM (Cruise Time), we need the estimated Ground Speed of the aircraft. With an expected tailwind of 10 kts at cruise altitude we obtain an (estimated) Ground Speed of:

$$120 \text{ kts} + 10 \text{ kts} = 130 \text{ kts}$$

For the cruise time, we obtain:

$$\frac{461.7 \text{ NM}}{130 \text{ kts}} = 3.55 \text{ h} = 3\text{h } 33'$$

The required amount of fuel for the cruise segment is:

$$3.55 \text{ h} \times 21.9 \text{ l/h} = 77.7 \text{ Litres}$$

The fuel flow of 21.9 l/h is obtained from table 5.2.8 on page 5-10 in the section for the power setting of 75 % MCP as follows:

With a temperature of 10°C in 4500 ft we obtain a density altitude of 5000 ft from chart 5.2.9, 5.2.10 or 5.2.11, respectively. The density altitude is the entry parameter in table 5.2.8 and we have to interpolate between the given values for 4000 and 6000 ft for our determined density altitude of 5000 ft. With the density altitude as the entry parameter instead of the pressure altitude we have already accounted for the deviation of the actual outside air temperature from ISA-conditions. An additional correction for the temperature difference to ISA in accordance with the correction information in table 5.2.8 which is more or less a correction for the difference in pressure and density altitude is not necessary.

The calculated total fuel amount required is obtained as follows:

|                                    |                    |
|------------------------------------|--------------------|
| Engine Start-up, Taxiing and Climb | 4.7 Litres         |
| Cruise                             | 77.7 Litres        |
| Descent                            | 0.7 Litres         |
| Total Fuel required                | <u>83.1 Litres</u> |

| Document No.:     | Issue: | Supersedes Issue: | Date:      | Page:  |
|-------------------|--------|-------------------|------------|--------|
| FM-AT01-1010-100E | A.12   | A.03 (15/04/2003) | 17/09/2008 | 5 - 21 |

If we assume to take-off with the maximum fuel capacity on board then the following reserve remains:

|                            |                    |
|----------------------------|--------------------|
| Usable Fuel amount         | 109.6 Litres       |
| Total Fuel amount required | - 83.1 Litres      |
| Fuel Reserve:              | <u>26.5 Litres</u> |

The actual Ground Speed of the aircraft has to be regularly checked and tracked during the flight as the basis for the checking of the flight time and the relation fuel amount required and left. If, for example, the expected tailwind of 10 kts is not experienced, the power setting will have to be reduced to 65 % MCP to achieve the same range with the fuel amount determined for the cruise leg with tailwind.

### LANDING DISTANCE

Before entering chart 5.2.13 on page 5-16 to determine the Landing Distance Required and the Ground Roll Required, the headwind and crosswind component of the wind relative to the runway direction has to be obtained from chart 5.2.3 on page 5-5.

Relative to the runway direction the wind comes at an angle of 50° from the left with 15 kts. Entering chart 5.2.3 with these values we obtain a Headwind Component of 9 kts and a Crosswind Component of 12 kts. The latter is within the approved range of 15 kts.

Determination of the Landing Mass:

|   |                 |
|---|-----------------|
| Take-off Mass                                   | 720 kg          |
| Fuel consumption (83.1 l x 0.73 kg/l = 60.6 kg) | - 60.6 kg       |
|   | <u>659.4 kg</u> |

Determination of the Landing Distance Required and the Ground Roll:

|  |       |
|--|-------|
| Landing Distance Required from a height of 50 ft | 375 m |
| Increment for Grass Runway (dry: +15%)           | 432 m |
| Ground Roll                                      | 160 m |
| Increment for Grass Runway (dry: +15%)           | 184 m |

The available runway length of 780 m is sufficient with the estimated Landing Mass. The reported Crosswind Component remains under the maximum approved limit of 15 kts.

-----

|                      |               |                          |              |              |
|----------------------|---------------|--------------------------|--------------|--------------|
| <i>Document No.:</i> | <i>Issue:</i> | <i>Supersedes Issue:</i> | <i>Date:</i> | <i>Page:</i> |
| FM-AT01-1010-100E    | A.12          | A.03 (15/04/2003)        | 17/09/2008   | 5 - 22       |

**5.2.16 Noise Characteristics**

- a) Noise Level Limit in dB(A) according to LSL, chapter X.: 72.3 dB(A)  
Certificated Noise Level 64.6 dB(A)
- Difference to the Noise Level Limit: 7.7 dB(A)

| <i>Document No.:</i> | <i>Issue:</i> | <i>Supersedes Issue:</i> | <i>Date:</i> | <i>Page:</i> |
|----------------------|---------------|--------------------------|--------------|--------------|
| FM-AT01-1010-100E    | A.12          | A.03 (15/04/2003)        | 17/09/2008   | 5 - 23       |

**SECTION 6**

**WEIGHT AND BALANCE / EQUIPMENT LIST**

|       |   | Page |
|-------|---|------|
| 6.1   | INTRODUCTION  | 6-2  |
| 6.2   | AIRCRAFT WEIGHING PROCEDURE                             | 6-3  |
| 6.2.1 | Aircraft Weighing Report                                | 6-5  |
| 6.3   | WEIGHT AND BALANCE DATA AND RECORD                      | 6-6  |
| 6.3.1 | Weight and Balance Record                               | 6-6  |
| 6.4   | WEIGHT AND BALANCE DETERMINATION FOR FLIGHT             | 6-7  |
| 6.4.1 | Moment Determination                                    | 6-8  |
| 6.4.2 | Weight and Moment Determination                         | 6-9  |
| 6.4.3 | Approved Centre of Gravity Range and Mass Moment Limits | 6-10 |
| 6.5   | EQUIPMENT LIST  | 6-11 |
| 6.5.1 | Effective Equipment List of the Aircraft                | 6-12 |

| <i>Document No.:</i> | <i>Issue:</i> | <i>Supersedes Issue:</i> | <i>Date:</i> | <i>Page:</i> |
|----------------------|---------------|--------------------------|--------------|--------------|
| FM-AT01-1010-100E    | A.12          | A.01 (05/06/2002)        | 17/09/2008   | 6 - 1        |

## 6.1 INTRODUCTION

The aircraft must be flown with a weight and centre of gravity position (C.G.) that is within the approved operating range defined in this section to guarantee safe operation, the specified flight performances and the proven flight characteristics.

It is within the responsibility of the pilot to ensure that the aircraft is properly loaded. The shift in C.G. location due to the fuel consumption during flight has always to be taken into consideration.

This section describes the weighing procedure of the aircraft and the procedure for the determination of the empty mass, the mass moment of the aircraft and the C.G. position.

Before delivery, the manufacturer provides each aircraft with its basic empty mass and mass moment as well as the C.G. location which have been determined within the conformity inspection process by an airplane weighing. This data is documented in the Aircraft Weighing Report (see paragraph 6.2.1) and in the Weight and Balance Record in paragraph 6.3.1 of this section.

Aircraft weighings have to be conducted at regular intervals as well as on special occasions in accordance with the applicable national operational and legal requirements.

Whenever new equipment or retrofits are installed into the aircraft, the resulting new basic empty mass, mass moment and C.G. location have to be determined and documented in the Weight and Balance Record of paragraph 6.3.1.

The following pages provide forms and means that are recommended to be used for the weighing of the aircraft and the determination of the required mass and balance data, such as the Aircraft Weighing Report (paragraph 6.2.1), the Weight and Balance Record (paragraph 6.3.1), and the Weight and Moment Determination Table (paragraph 6.4.2).

|             |
|-------------|
| <b>NOTE</b> |
|-------------|

If any modifications or repairs are implemented into the aircraft, the new basic empty mass, mass moment and C.G. location will have to be determined in accordance with the respective national aviation regulations.

An authorized person (Certifying Staff) has to certify the new basic empty mass and mass moment as well as C.G. position and the maximum useable load in the Weight and Balance Record.

| <i>Document No.:</i> | <i>Issue:</i> | <i>Supersedes Issue:</i> | <i>Date:</i> | <i>Page:</i> |
|----------------------|---------------|--------------------------|--------------|--------------|
| FM-AT01-1010-100E    | A.12          | A.01 (05/06/2002)        | 17/09/2008   | 6 - 2        |

## 6.2 AIRCRAFT WEIGHING PROCEDURE

Before conducting the weighing, the aircraft and its equipment must explicitly meet the weighing configuration specified below. In principal, the aircraft has to be weighed in an airworthy condition.

### Weighing Configuration:

- a) Aircraft with:
- Brake Fluid
  - Engine Oil (3 liters)
  - Coolant (2,5 liters)
  - Unusable Fuel (10,4 liters)
- b) Equipment in accordance with effective equipment list (Para. 6.5).

The determination of the empty mass and the associated empty mass C.G. position should be accomplished as follows:

Prepare the aircraft to meet the above specified weighing configuration. Place scales or its sensor supports under each wheel and longitudinally level out the aircraft in accordance with the sketch and description provided on the Aircraft Weighing Report in paragraph 6.2.1. In addition make sure that the aircraft is also laterally approximately levelled out.

When the aircraft is levelled out, drop the perpendicular with a plummet from the right wing leading edge at the fuselage-wing intersection and mark the point on the ground. Repeat this on the left side of the fuselage and then draw a line between the obtained points. From this reference line measure the distances  $D_L$ ,  $D_R$ , and  $D_N$  (refer also to the sketch on the Aircraft Weighing Report in paragraph 6.2.1).

The basic empty mass, the empty mass moment and the empty mass C.G. position may then be determined by the following equations:

Empty Mass  $m_{empty}$  [kg]:

$$m_{empty} = m_L + m_R + m_N$$

Empty Mass Moment  $MO_{empty}$  [Kgm]:

$$MO_{empty} = m_L \cdot D_L + m_R \cdot D_R + m_N \cdot D_N$$

Empty Mass C.G. Position  $D_{CG}$  [m]:

$$D_{CG} = \frac{MO_{empty}}{m_{empty}}$$

| <i>Document No.:</i> | <i>Issue:</i> | <i>Supersedes Issue:</i> | <i>Date:</i> | <i>Page:</i> |
|----------------------|---------------|--------------------------|--------------|--------------|
| FM-AT01-1010-100E    | A.12          | A.01 (05/06/2002)        | 17/09/2008   | 6 - 3        |

**NOTE****Used Sign Convention:**

The lever arms of the main landing gear wheels  $D_L$  and  $D_R$  have a positive (+) sign and that of the nose gear wheel  $D_N$  a negative (-) sign.

| <i>Document No.:</i> | <i>Issue:</i> | <i>Supersedes Issue:</i> | <i>Date:</i> | <i>Page:</i> |
|----------------------|---------------|--------------------------|--------------|--------------|
| FM-AT01-1010-100E    | A.12          | A.01 (05/06/2002)        | 17/09/2008   | 6 - 4        |



**6.2.1 Aircraft Weighing Report**

Model: AT01 Serial No: \_\_\_\_\_ Registration No: \_\_\_\_\_

Data in accordance with AFM

Reference Datum:

Horizontal Reference Line:

Occasion for Weighing: \_\_\_\_\_

Leading edge of wing root rib.

Place a wedge (5.5°) on fuselage tube as shown in the sketch below and level out the a/c in its longitudinal axis using a spirit level.

Weighing Configuration:

Including brake fluid, engine oil, coolant and unusable fuel (10.4 litres).

Effective Equipment List - dated: \_\_\_\_\_

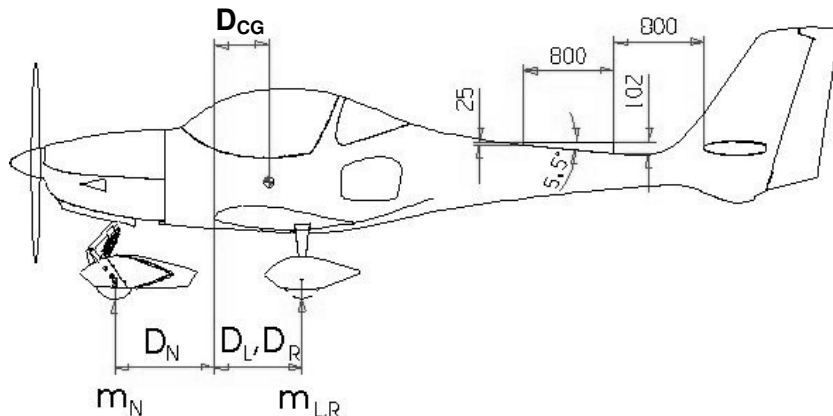

| Position                                   | Gross [kg] | Tare [kg] | Net Mass [kg] | Lever Arm [m] |
|--|------------|-----------|---------------|---------------|
| Nose Wheel                                 |            |           | $m_N =$       | $D_N = -$     |
| Left Main Wheel                            |            |           | $m_L =$       | $D_L = +$     |
| Right Main Wheel                           |            |           | $m_R =$       | $D_R = +$     |
| Empty Mass $m_{empty} = m_N + m_L + m_R =$ |            |           |               | [kg]          |

Empty Mass Moment:  $MO_{empty} = m_N \cdot D_N + m_L \cdot D_L + m_R \cdot D_R =$  \_\_\_\_\_ [kgm]

Empty Mass C.G. position: = Empty Mass Moment / Empty Mass =  
 $D_{CG} = MO_{empty} / m_{empty} =$  \_\_\_\_\_ [m]

|                     |                     |   |
|---------------------|---------------------|---|
| Maximum Usable Load | + MTOW [kg]         | + |
|                     | - Empty Mass [kg]   | - |
|                     | = Max. Useable Load | = |

Data for Entering in the Airplane Flight Manual Para. 6.3.

|                 |       |                         |  |
|-----------------|-------|-------------------------|--|
| Empty Mass [kg] |       | Empty Mass Moment [kgm] |  |
| Location / Date | Stamp | Signature               |  |

|                   |        |                   |            |       |
|-------------------|--------|-------------------|------------|-------|
| Document No.:     | Issue: | Supersedes Issue: | Date:      | Page: |
| FM-AT01-1010-100E | A.12   | A.01 (05/06/2002) | 17/09/2008 | 6 - 5 |



## 6.4 WEIGHT AND BALANCE DETERMINATION FOR FLIGHT

In order to operate the aircraft within the approved mass and C.G. limits, the take-off mass and the associated C.G. position must be determined dependent on the loading for the planned flight.

Use the tables and charts provided on the following pages for the mass and C.G. position determination:

Paragraph 6.4.1 Moment Determination (Loading Graph)

Paragraph 6.4.2 Weight and Moment Determination

Paragraph 6.4.3 Approved Centre of Gravity Range and Mass Moment Limits Graph

The take-off mass and the corresponding C.G. location has to be determined as follows:

1. Take the basic empty mass  $m_{empty}$  and the empty mass moment  $MO_{empty}$  from the current effective Aircraft Weighing Report or the Weight and Balance Record, respectively, and enter them into the respective fields in the *Weight and Moment Determination table* (paragraph 6.4.2).
2. Determine the individual masses of fuel, pilot, passenger and baggage to be carried in the aircraft and enter these data into the respective fields in the *Weight and Moment Determination table* (para. 6.4.2). Use the *Loading Graph (6.4.1)* to obtain the individual moments for fuel, baggage, pilot and passenger and enter their values also into the respective fields in the *Weight and Moment Determination table*.
3. Determine the take-off mass by adding the individual masses of fuel, pilot, passenger and baggage to the basic empty mass. Determine the take-off mass moment by adding the individual mass moments of the fuel, pilot, passenger and baggage to the basic empty mass moment.
4. Obtain the take-off C.G. location by entering the "Approved C.G. Range and Mass Moment Limits" diagram in paragraph 6.4.3 with take-off mass and take-off mass moment. Verify that the C.G. location falls into the approved C.G. range. The C.G. location may alternatively be determined by dividing the take-off mass moment by the take-off mass. It has then to be verified that the calculated take-off C.G. position is within the approved C.G. range.

| <i>Document No.:</i> | <i>Issue:</i> | <i>Supersedes Issue:</i> | <i>Date:</i> | <i>Page:</i> |
|----------------------|---------------|--------------------------|--------------|--------------|
| FM-AT01-1010-100E    | A.12          | A.01 (05/06/2002)        | 17/09/2008   | 6 - 7        |

**6.4.1 Moment Determination**

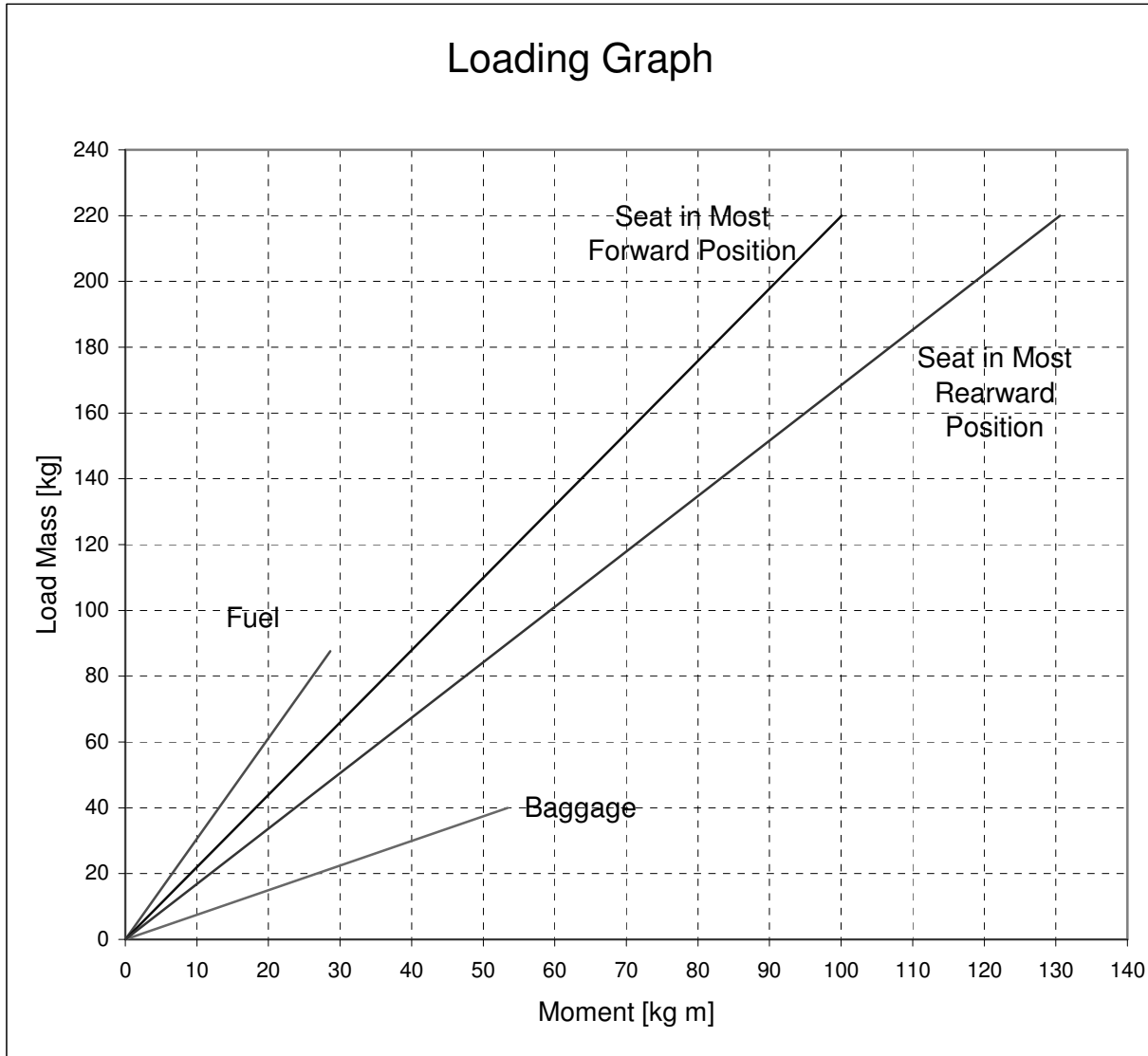

| <i>Document No.:</i> | <i>Issue:</i> | <i>Supersedes Issue:</i> | <i>Date:</i> | <i>Page:</i> |
|----------------------|---------------|--------------------------|--------------|--------------|
| FM-AT01-1010-100E    | A.12          | A.01 (05/06/2002)        | 17/09/2008   | 6 - 8        |

**6.4.2 Weight and Moment Determination**

| Weight and Moment Determination   | AQUILA AT01 - Example   |              | Registration No. |               |
|---|---|--------------|------------------|---------------|
|   | Mass [kg]   | Moment [kgm] | Mass [kg]        | Moment [kg m] |
| 1.) <b>EMPTY MASS and MOMENT</b><br>(take from the effective Aircraft Weighing Report or the Weight and Balance Record) <b>including unusable fuel, engine oil, and coolant</b> | 490   | 210          |                  |               |
| 2.) <b>PILOT + PASSENGER</b><br>Lever Arm: 0.515 m  | 82  | 42.2         |                  |               |
| 3.) <b>BAGGAGE</b><br>Lever Arm: 1.3 m  | 20  | 26           |                  |               |
| 4.) <b>A/C MASS and MOMENT WITHOUT FUEL</b><br>( = sum of 1-3)  | 592   | 278.2        |                  |               |
| 5.) <b>LOADED FUEL</b><br>(loaded <b>USABLE</b> Fuel, Fuel Density: 0.72 kg/l)<br>Lever Arm: 0.325 m  | $109.6 \text{ l} \times 0,72 = 78.9 \text{ kg}$   | 26           |                  |               |
| 6.) <b>A/C MASS and MOMENT INCLUDING FUEL</b><br>( = sum of 4-5)  | 670.9   | 304.2        |                  |               |
| 7.) <b>Use the values in Point 6 to determine the C.G. position in the diagram "Approved Centre of Gravity Range and Mass Moment Limits" in paragraph 6.4.3.</b>                | <i>The C.G. Pos. (453 mm) is within the approved range. Refer also to the example in the mentioned diagram.</i> |              |                  |               |

|                   |        |                   |            |       |
|-------------------|--------|-------------------|------------|-------|
| Document No.:     | Issue: | Supersedes Issue: | Date:      | Page: |
| FM-AT01-1010-100E | A.12   | A.01 (05/06/2002) | 17/09/2008 | 6 - 9 |

**6.4.3 Approved Centre of Gravity Range and Mass Moment Limits**

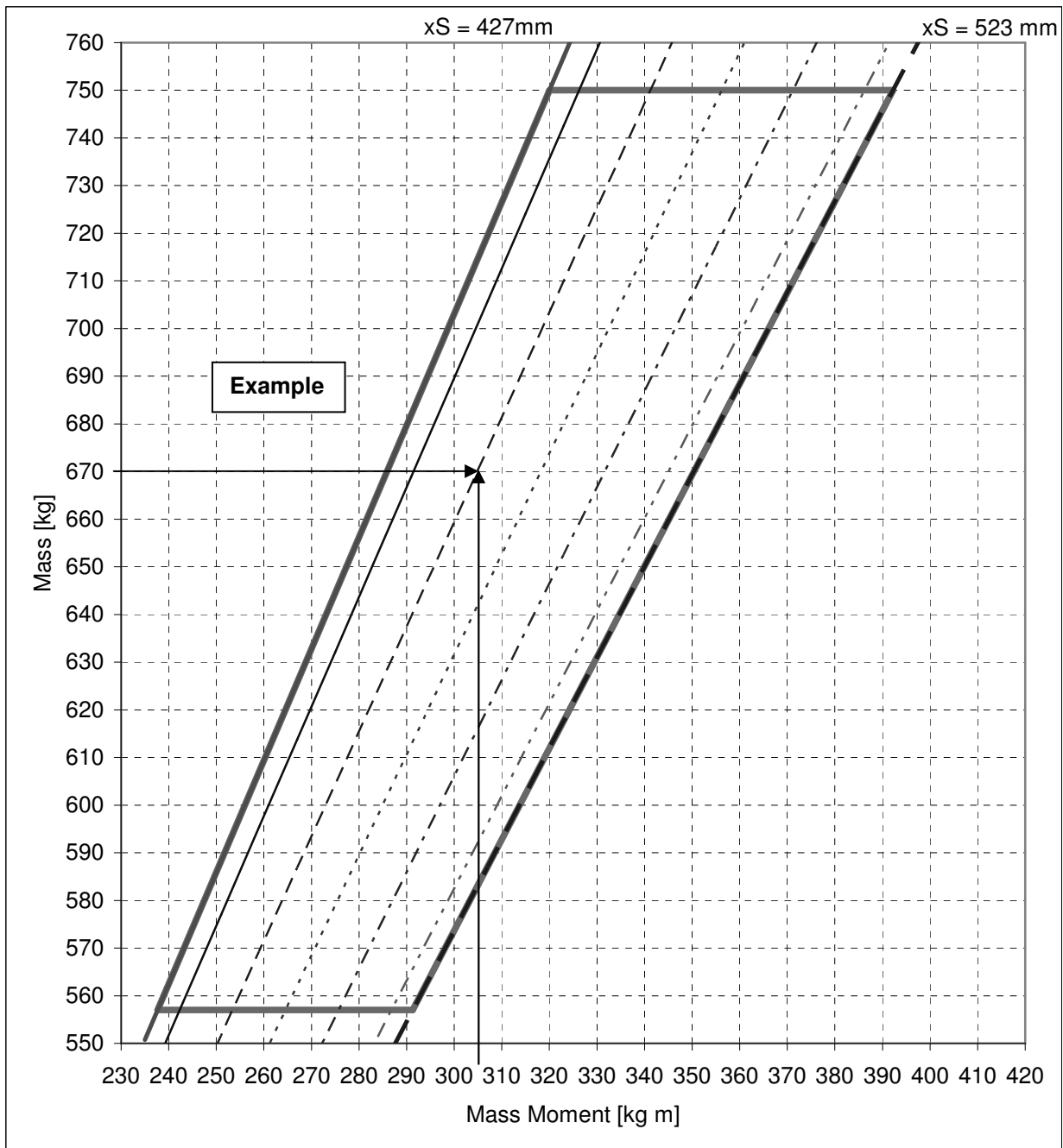

| <i>Document No.:</i> | <i>Issue:</i> | <i>Supersedes Issue:</i> | <i>Date:</i> | <i>Page:</i> |
|----------------------|---------------|--------------------------|--------------|--------------|
| FM-AT01-1010-100E    | A.12          | A.01 (05/06/2002)        | 17/09/2008   | 6 - 10       |

## 6.5 EQUIPMENT LIST

The equipment list on the following pages includes all instruments, avionic systems and other equipment installed in the present airplane. A list of all instruments, avionic systems and other equipment that is approved and available for the installation in the AQUILA AT01 is contained in the Maintenance Manual, document MM-AT01-1020-100.

All changes in or the retrofitting of equipment has to be documented in the present equipment list in this handbook. It has to be kept up to date to reflect the actual current equipment status.

The equipment list in this handbook contains the following information:

1. Designation/description, manufacturer, model/P/N and S/N of the instrument, avionic system and other equipment
2. Indication of the installation location OR lever arm in [mm] from the reference datum. In this connexion it has to be pointed out that lever arms with positive sign indicate locations rearward of the reference datum and lever arms with negative sign indicate locations forward of the reference datum.

|             |
|-------------|
| <b>NOTE</b> |
|-------------|

The installation of additional equipment or the change of installed equipment, respectively, has to be carried out in accordance with the data provided in the Maintenance Manual, document MM-AT01-1020-100. The retrofitting of equipment has to be conducted in accordance with the applicable Service Bulletin (document code SB-AT01-...). In case of doubt, the type certificate holder or the production/maintenance organisation of AQUILA Aviation has to be contacted.

In line with every equipment change or retrofit, the basic empty mass, empty mass moment, empty mass C.G. location and the maximum usable load has to be re-determined and documented in the Aircraft Weighing Report as well as in the Weight and Balance Report in paragraph 6.3.1. This can be accomplished by calculation, if the individual masses and lever arms of the equipment are known, or by means of conducting a new weighing of the complete aircraft in accordance with paragraph 6.2. The new C.G. location must be within the approved C.G. range.

| <i>Document No.:</i> | <i>Issue:</i> | <i>Supersedes Issue:</i> | <i>Date:</i> | <i>Page:</i> |
|----------------------|---------------|--------------------------|--------------|--------------|
| FM-AT01-1010-100E    | A.12          | A.01 (05/06/2002)        | 17/09/2008   | 6 - 11       |









## SECTION 7

### DESCRIPTION OF THE AIRCRAFT AND ITS SYSTEMS

|       |   | Page |
|-------|---|------|
| 7.1   | INTRODUCTION                              | 7-4  |
| 7.2   | AIRFRAME                                  | 7-5  |
| 7.2.1 | Fuselage                                  | 7-5  |
| 7.2.2 | Wing                                      | 7-5  |
| 7.2.3 | Empennage                                 | 7-6  |
| 7.3   | FLIGHT CONTROLS                           | 7-6  |
| 7.3.1 | Aileron Control                           | 7-6  |
| 7.3.2 | Elevator Control and Trim System          | 7-7  |
| 7.3.3 | Rudder Control                            | 7-7  |
| 7.3.4 | Flap Control and Flap Position Indication | 7-8  |
| 7.3.5 | Control Stick Lock                        | 7-8  |
| 7.4   | INSTRUMENT PANEL (Standard Equipment)     | 7-9  |
| 7.4.1 | Flight Instruments                        | 7-10 |
| 7.4.2 | Switches and Other Controls               | 7-10 |
| 7.4.3 | Cabin Heat                                | 7-11 |
| 7.4.4 | Cabin Ventilation                         | 7-11 |
| 7.5   | UNDERCARRIAGE                             | 7-11 |
| 7.5.1 | Nose Landing Gear and Nose Gear Steering  | 7-11 |
| 7.5.2 | Main Landing Gear and Brake System        | 7-12 |
| 7.5.3 | Parking Brake                             | 7-12 |

| <i>Document No.:</i> | <i>Issue:</i> | <i>Supersedes Issue:</i> | <i>Date:</i> | <i>Page:</i> |
|----------------------|---------------|--------------------------|--------------|--------------|
| FM-AT01-1010-100E    | A.14          | A.12 (17/09/2008)        | 03/09/2009   | 7 - 1        |

|        |   |      |
|--------|---|------|
| 7.6    | SEATS, SEATBELTS AND HARNESSSES             | 7-12 |
| 7.6.1  | Seat Adjustment                             | 7-13 |
| 7.7    | BAGGAGE COMPARTMENT                         | 7-13 |
| 7.8    | CANOPY                                      | 7-14 |
| 7.9    | POWER PLANT                                 | 7-15 |
| 7.9.1  | Engine                                      | 7-16 |
| 7.9.2  | Throttle and Choke                          | 7-17 |
| 7.9.3  | Propeller and Propeller Control             | 7-18 |
| 7.9.4  | Carburettor Heat                            | 7-18 |
| 7.10   | FUEL SYSTEM                                 | 7-19 |
| 7.10.1 | Fuel storage and Ventilation                | 7-21 |
| 7.10.2 | Fuel Selector / Shut-Off Valve              | 7-21 |
| 7.10.3 | Electrical Fuel Pump and Fuel Strainer      | 7-22 |
| 7.10.4 | Fuel Level Indication                       | 7-22 |
| 7.10.5 | Fuel Tank Drainage System                   | 7-23 |
| 7.11   | ELECTRICAL SYSTEM                           | 7-24 |
| 7.11.1 | Power Supply and Battery System             | 7-24 |
| 7.11.2 | Ignition System and Starter                 | 7-25 |
| 7.11.3 | Electrical Equipment and Circuit Breakers   | 7-27 |
| 7.11.4 | Voltmeter and Ammeter                       | 7-27 |
| 7.11.5 | Alternator Warning Light                    | 7-27 |
| 7.11.6 | Fuel Pressure Warning Light                 | 7-28 |
| 7.11.7 | Engine Instruments and Fuel Level Indicator | 7-28 |
| 7.11.8 | External Power Unit                         | 7-28 |

| <i>Document No.:</i> | <i>Issue:</i> | <i>Supersedes Issue:</i> | <i>Date:</i> | <i>Page:</i> |
|----------------------|---------------|--------------------------|--------------|--------------|
| FM-AT01-1010-100E    | A.14          | A.12 (17/09/2008)        | 03/09/2009   | 7 - 2        |

|      |                                     |      |
|------|-------------------------------------|------|
| 7.12 | PITOT-STATIC SYSTEM                 | 7-29 |
| 7.13 | STALL WARNING SYSTEM                | 7-30 |
| 7.14 | AVIONICS                            | 7-31 |
| 7.15 | RESERVED (Intentionally left blank) | 7-32 |

| <i>Document No.:</i> | <i>Issue:</i> | <i>Supersedes Issue:</i> | <i>Date:</i> | <i>Page:</i> |
|----------------------|---------------|--------------------------|--------------|--------------|
| FM-AT01-1010-100E    | A.14          | A.12 (17/09/2008)        | 03/09/2009   | 7 - 3        |

## 7.1 INTRODUCTION

Section 7 of the Airplane Flight Manual contains a general description of and operating instructions for the aircraft and its systems.

Refer to Section 9 for the description of and operating instructions for the optional equipment and systems.

| <i>Document No.:</i> | <i>Issue:</i> | <i>Supersedes Issue:</i> | <i>Date:</i> | <i>Page:</i> |
|----------------------|---------------|--------------------------|--------------|--------------|
| FM-AT01-1010-100E    | A.14          | A.12 (17/09/2008)        | 03/09/2009   | 7 - 4        |

## 7.2 AIRFRAME

The majority of the aircraft structure is constructed in composite design. Glass fibre (GFRP) as well as carbon fibre materials (CFRP) are used that are bedded into an epoxy resin matrix. The aircraft structure consists of both, monolithic GFRP or CFRP shells / structural components and sandwich shells with a structural foam core based on PVC.

### 7.2.1 Fuselage

The fuselage forms one structural unit along with the vertical and horizontal stabilizers. The fuselage and vertical stabilizer as a monolithic component consists of two half-shells. While the fuselage portion of the half-shells is fabricated from solid fibreglass laminate, the vertical stabilizer portion has a sandwich structure. The GFRP-skin of the fuselage is reinforced by four carbon fibre stringers, arranged lengthwise along the entire fuselage.

Four ring frames and a baggage compartment bulkhead support and stiffen the fuselage shells in the tail boom section. In the forward fuselage section adjacent to the wing-body-intersection, the landing gear frame, seat frame and the shear frame of the wing-body-joint are positioned for the transmission of the several loads into the fuselage structure and to stiffen the structure in these sections. At its front side, the fuselage ends with the firewall at which the engine is attached to. The firewall, designed as a GFRP/CFRP sandwich composite, has on its front side in the engine compartment a fire protection lining that consists of a special fire-resistant ceramic fleece and a stainless steel sheet.

The landing gear frame, which supports together with the seat frame the main landing gear struts, is supplemented in the upper section by a compact CFRP/GFRP roll-over bar.

### 7.2.2 Wing

The wing is designed with a triple trapezoid planform that tapers off in winglets at its wing tips. The wing consists of an upper and a lower shell in GFRP sandwich composite design that are both locally reinforced by CFRP unidirectional straps in the region of the wing spar bonding area. Both, the left and the right wing form one structural unit which are connected by a rigid wing main spar in the middle section. The wing spar is a continuous unit from wing tip to wing tip and has a "double-T" (I-beam) cross-section with chords manufactured from CFRP unidirectional fibres (rovings) and a GFRP sandwich web.

Each wing half ends on its inboard side with a forward and rearward root rib, separated by the wing spar, which are joined to the shear frame in the fuselage mid section by a shear bolt on each fwd and rearward root rib. The four shear bolts are installed from the cabin through the fuselage bushings into the wing bolt housings in the wing root ribs and axially secured with bolts.

| <i>Document No.:</i> | <i>Issue:</i> | <i>Supersedes Issue:</i> | <i>Date:</i> | <i>Page:</i> |
|----------------------|---------------|--------------------------|--------------|--------------|
| FM-AT01-1010-100E    | A.14          | A.12 (17/09/2008)        | 03/09/2009   | 7 - 5        |

The outboard end of each wing half is shaped into a winglet, which contains the NAV-Lights, Anti-Collision Lights as well as the outlets of the fuel tank vents, to reduce the induced drag of the airplane. The inboard third of each wing half contains an integral fuel tank with a fuel capacity of 60 Litres which is integrated into the structure fwd of the wing spar.

The ailerons are located at the wing trailing edge in the outboard section of the wing near the wing tips. The ailerons are designed as semi-monocoque sandwich composite structures with an upper and lower shell consisting of structural foam cores embedded into a glass fibre laminate reinforced by carbon fibre plies.

In the inboard section of the trailing edge adjacent to the inboard end of the aileron, each wing is equipped with a single slotted flap that is attached on hinged lever arms to the trailing edge structure of the wing. Each flap is designed as a semi-monocoque sandwich composite structure with an upper and lower shell consisting of a structural foam core embedded into a glass and carbon fibre hybrid laminate.

The fulcrums of the flaps are located below the lower surface of the wing enabling an increasing gap between the wing trailing edge and the leading edge of the flap while the flaps are extending. As a result, the airflow over the upper surface of the flap is stabilized and higher angles of attack can be flown before stall sets in. Consequently, the lift of the aircraft is increased associated with a rise in drag as a detrimental effect.

### 7.2.3 Empennage

The vertical and horizontal stabilizers as well as the elevator and rudder are constructed in semi-monocoque sandwich composite design consisting of shells fabricated from GFRP sandwich composites reinforced by carbon fibre plies.

Both, the vertical and horizontal stabilizer are stiffened by a main spar and a rear web where hinge joints for the rudder and elevator attachment are integrated.

The horizontal stabilizer assembly is firmly bonded into the fuselage and cannot be removed. The VHF-NAV/COM antenna is located inside of the vertical stabilizer bonded on the inner surface of the shell.

## 7.3 FLIGHT CONTROLS

### 7.3.1 Aileron Control

The ailerons are operated by side deflections of both control sticks which are mechanically linked together to form a dual flight control system.

The control input is transferred to the control surfaces solely by push rods. In the mid section of the wing spar, the differentiation lever for the aileron control is mounted to adjust the deflection ratio between positive and negative deflection of the aileron control surfaces (differentiation). The deflections of the aileron control surfaces are effectively limited by adjustable stops that confine the travel of the control sticks.

| <i>Document No.:</i> | <i>Issue:</i> | <i>Supersedes Issue:</i> | <i>Date:</i> | <i>Page:</i> |
|----------------------|---------------|--------------------------|--------------|--------------|
| FM-AT01-1010-100E    | A.14          | A.12 (17/09/2008)        | 03/09/2009   | 7 - 6        |



### 7.3.2 Elevator Control and Trim System

The elevator is operated by forward and rearward deflections of either control stick of the dual flight control system.

The control input is transferred to the control surfaces solely by push rods. The deflections of the elevator control surfaces are effectively limited by adjustable stops that confine the travel of the control stick.

An electrical trim system is installed into the aircraft that adjusts the pitch control force by modifying spring loads exerted on the elevator push rod. A failure of the trim system, such as trim-runaway, does not affect the aircraft controllability, only the control stick forces may become higher. The aircraft is trimmed nose down by pressing down the forward end of the trim switch whereas a nose up trimming is accomplished by pressing down the rear end of the switch. The actual trim position of the aircraft is indicated on the LED-bar of the Trim Position Indicator located in the upper centre section of the instrument panel.

The trim switch activates an electrical trim actuator that is mounted parallel to the elevator pushrod under the floor panel of the baggage compartment. The trim actuator changes the preload of a pair of springs that exerts a defined force to the elevator push rod to adjust the pitch control force as selected by the pilot.

The electrical circuit of the trim system is protected by a circuit breaker that can be pulled in the case of a trim system malfunction. For the LEDs of the Trim Position Indicator, a separate circuit breaker is provided. All related circuit breakers are installed well accessible in the right section of the instrument panel.

### 7.3.3 Rudder Control

The rudder is operated by the rudder pedals in such a way that a left pedal input is transferred into a movement of the aircraft nose towards the left side and vice versa. Both, the right-hand rudder pedals as well as the left-hand rudder pedals of each seat are linked together by separated rudder control coupling shafts. The pedals themselves are attached at the end of the actuator arms of each control coupling shaft. In this way, a dual rudder control system is achieved.

Rudder control inputs are transferred by control cables that are specially guided to minimize friction. The control surface travel is limited by stops at the lower rudder attachment fitting.

Precise control and a good manoeuvrability during taxiing on ground is accomplished by a direct linkage of the nose wheel steering mechanism with the rudder pedals (refer also to para. 7.5.1 of this manual). To gain a minimum turn radius the brakes may be additionally used as a supportive measure.

The distance between the seat and the rudder pedals can be easily adjusted to the pilot's need by a seat adjustment that is in a wide range continuously adjustable fore and aft (for seat adjustment, refer to para. 7.5.1 of this handbook).

| <i>Document No.:</i> | <i>Issue:</i> | <i>Supersedes Issue:</i> | <i>Date:</i> | <i>Page:</i> |
|----------------------|---------------|--------------------------|--------------|--------------|
| FM-AT01-1010-100E    | A.14          | A.12 (17/09/2008)        | 03/09/2009   | 7 - 7        |

**CAUTION**

Check the proper seat position before every engine start-up to ensure the availability of the full operating range of the nose wheel steering and the toe brakes.

**7.3.4 Flap Control and Flap Position Indication**

The flaps are operated and fixed in the selected position by an electrical flap actuator. A three-position selector switch is incorporated in the instrument panel for flap operation. The switch position in combination with the associated indicator light correlates in its orientation to the position of the trailing edge of the flap when extended in the 35° landing position, in the 17° take-off position and when retracted (three-position selector switch is in its most up position).

If the flap switch is brought into another position, the flaps will extend until the selected flap position is reached and the flap movement will be automatically stopped. As the flap actuator has a reduction gear and a self-locking spindle, the flaps will be fixed in position in case of an electrical power failure.

Colour markings on the flap leading edge (see also page 2-10) offer an additional reliable possibility for a visual check of the flap position. The flap position correspond to the coloured bar that is barely visible between the leading edge of the flap and the trailing edge of the upper wing shell (for the colour code, refer to section 2.16 which contains all placards and markings).

The electrical circuit of the flap control system is protected by a 10A circuit breaker that can be manually pulled if required.

For the LED's of the flap position indication, a separate circuit breaker is provided. All related circuit breakers are installed well accessible in the right section of the instrument panel.

**7.3.5 Control Stick Lock**

While parking, the control stick should be secured to prevent damage to the parked aircraft by gusts or strong winds. For that purpose, pull the stick up to the control stop and secure the stick in this position with the safety belt by closing the safety belt locking mechanism and tightening the belt straps.

| <i>Document No.:</i> | <i>Issue:</i> | <i>Supersedes Issue:</i> | <i>Date:</i> | <i>Page:</i> |
|----------------------|---------------|--------------------------|--------------|--------------|
| FM-AT01-1010-100E    | A.14          | A.12 (17/09/2008)        | 03/09/2009   | 7 - 8        |

**7.4 INSTRUMENT PANEL (Standard Equipment)**

**NOTE:**  
Items 13, 14 and 15 may be arranged  
interchanged among each other with  
regard to their installation position.

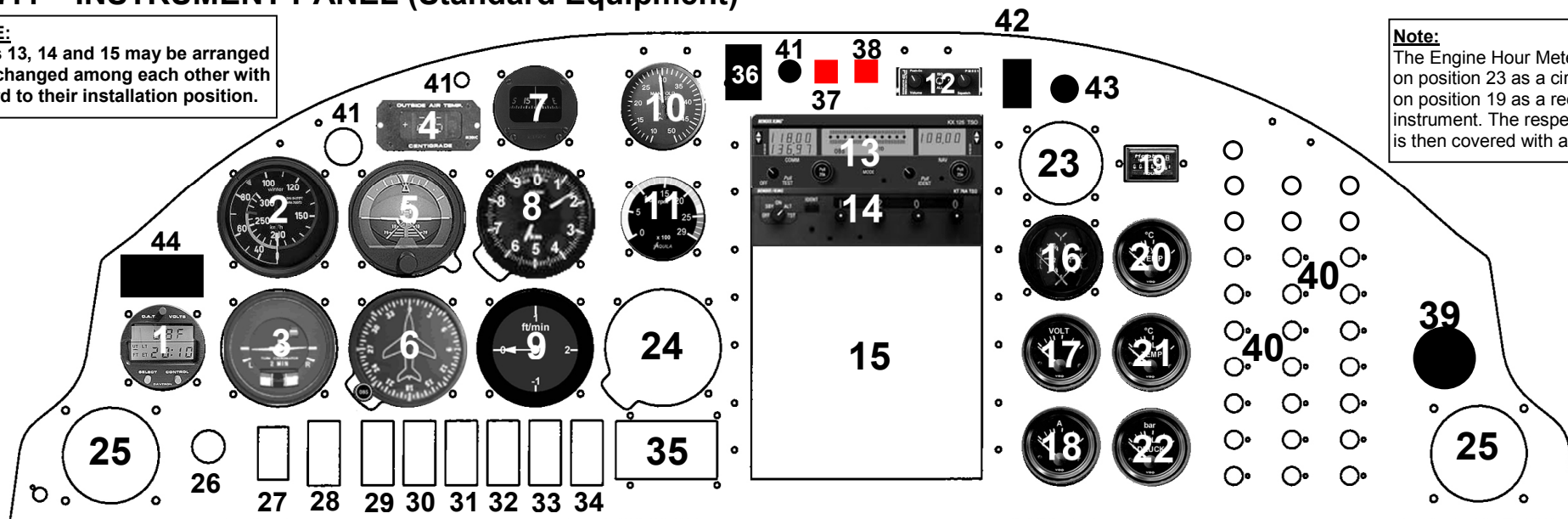

**Note:**  
The Engine Hour Meter is either installed  
on position 23 as a circular instrument or  
on position 19 as a rectangular  
instrument. The respective other position  
is then covered with a plate.

For minimum instrument requirements, refer to Section 2, Paragraph 2.12, of this manual.

| No. | Description            | No. | Description               | No. | Description               | No. | Description              | No. | Description              | No. | Description               |
|-----|------------------------|-----|---------------------------|-----|---------------------------|-----|--------------------------|-----|--------------------------|-----|---------------------------|
| 1   | Cockpit Watch          | 9   | Variometer                | 17  | Voltmeter                 | 25  | Ventilation Nozzle       | 33  | Instrument Light Switch  | 41  | Reserved.                 |
| 2   | Airspeed Indicator     | 10  | Manifold Press. Indicator | 18  | Ampèremeter               | 26  | Ignition Switch          | 34  | Cabin Light Switch       | 42  | ELT-Rem. Contr. (opt.)    |
| 3   | Turn Coordinator       | 11  | RPM-Indicator (Prop.)     | 19  | Engine Hour Meter         | 27  | ALT/BAT-Switch           | 35  | Flap Control Switch      | 43  | Instr. Panel Light Switch |
| 4   | OAT-Indicator          | 12  | Intercom PM 501 (opt.)    | 20  | Cyl. Head Temp. Indicator | 28  | Electrical Fuel Pump     | 36  | Trim Position Indicator  | 44  | FLARM Display (opt.)      |
| 5   | Attitude Gyro (ADI)    | 13  | COM/NAV                   | 21  | Oil Temp. Indicator       | 29  | Master Switch Avionics   | 37  | Alternator Warning Light |     |                           |
| 6   | Directional Gyro (HSI) | 14  | Transponder               | 22  | Oil Pressure Indicator    | 30  | NAV-Light Switch         | 38  | Fuel Press. Warn. Light  |     |                           |
| 7   | Compass                | 15  | Multifunctional Display   | 23  | Engine Hour Meter         | 31  | Anti-Collision-Light Sw. | 39  | 12VDC-Receptacle         |     |                           |
| 8   | Altimeter              | 16  | Fuel Level Indicator      | 24  | Course Dev. Ind. (opt.)   | 32  | Landing Light Switch     | 40  | Circuit Breakers         |     |                           |

|                      |               |                          |              |              |
|----------------------|---------------|--------------------------|--------------|--------------|
| <i>Document No.:</i> | <i>Issue:</i> | <i>Supersedes Issue:</i> | <i>Date:</i> | <i>Page:</i> |
| FM-AT01-1010-100E    | A.14          | A.12 (17/09/2008)        | 03/09/2009   | 7 - 9        |

**7.4.1 Flight Instruments**

The flight instruments are located in the instrument panel in front of the pilot's seat.

**7.4.2 Switches and Other Controls**

The switches for all electrical systems are arranged in a row below the flight instruments on the right side adjacent to the ignition switch.

On the control panel below the midsection of the instrument panel, the control elements for the Carburettor Heat, Choke and the Cabin Heat are located. The Throttle Lever and the Propeller Control Lever (with a blue star-shaped knob) are located well accessible in the forward section of the centre pedestal. Rearward of the fore-mentioned control elements, the Trim Switch, the Fuel Selector/Shut-off Valve and the Parking Brake Control Lever are positioned in the rear section of the centre pedestal between the seats.

The pulling of the control elements for the Carburettor Heat, Choke, Cabin Heat and Parking Brake causes the activation of the respective system.

For example, if the control element for the Choke is pulled the starting carburettors will be opened to enrich the mixture for the start-up of the cold engine, but only if the Throttle Lever is in the IDLE position (rear stop). The choke control element is spring loaded, i.e. if the control knob is released the control element goes automatically back into the off-position.

Full power and minimum propeller pitch (Take-off Position) is adjusted by moving both the Throttle and Propeller Control to its most forward positions (up to the stops).

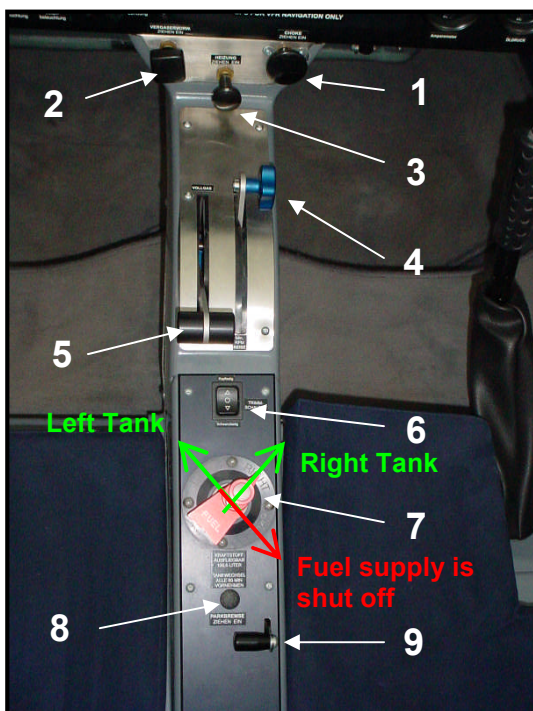

| No. | Description                      |
|-----|----------------------------------|
| 1   | Choke Control Element            |
| 2   | Carburettor Heat Control Element |
| 3   | Cabin Heat Control Element       |
| 4   | Propeller Control Lever          |
| 5   | Throttle Lever                   |
| 6   | Trim Switch                      |
| 7   | Fuel Selector/Shut-off Valve     |
| 8   | Reserved                         |
| 9   | Parking Brake Control Element    |

| Document No.:     | Issue: | Supersedes Issue: | Date:      | Page:  |
|-------------------|--------|-------------------|------------|--------|
| FM-AT01-1010-100E | A.14   | A.12 (17/09/2008) | 03/09/2009 | 7 - 10 |

### 7.4.3 Cabin Heat

For the cabin heating, ram air is heated in a shrouded chamber at the exhaust muffler and flows through a duct into the cabin if the heat control valve is opened. Behind the firewall, the heated air is subdivided for windshield defrosting and cabin heating. The control element to open or close the heat control valve is located in the control panel below the midsection of the instrument panel.

### 7.4.4 Cabin Ventilation

Two adjustable ventilation nozzles are located on both sides of the instrument panel to supply the cabin with fresh air. The amount and direction of fresh airflow can be adjusted individually for each seat by pivot-mounted nozzle outlets. If required, the sash windows of the canopy may additionally be opened for the ventilation of the cabin.

## 7.5 UNDERCARRIAGE

The landing gear consists of a steerable nose gear that is equipped with a shock absorber and a main landing gear. To provide precise control of the aircraft while taxiing on ground, the nose gear strut is directly linked with the rudder pedals. The main gear struts are designed as leaf springs to absorb the touch-down loads during landing. Hydraulically actuated disc brakes are provided on the main gear wheels which are activated by tilting the rudder pedals in the forward direction.

Because of the robust landing gear and the 5.00 x 5 wheels on the nose and main landing gear in combination with sturdy wheel fairings, the aircraft is suitable for the operation on airfields with grass runway.

### 7.5.1 Nose Landing Gear and Nose Gear Steering

The nose landing gear consists of a tubular steel strut that is attached pivot-mounted to the engine frame support.

A portion of the nose gear loads is directly transferred into the front structure of the fuselage via the lower attachment fittings of the engine frame support by two support struts.

Good shock absorption and suspension characteristics are provided by a shock absorber unit equipped with stacked rubber springs which acts directly on the nose wheel fork.

The steering of the nose wheel is accomplished by a spring loaded steering rod assembly that connects the nose gear steering arm at the upper end of the nose gear

| <i>Document No.:</i> | <i>Issue:</i> | <i>Supersedes Issue:</i> | <i>Date:</i> | <i>Page:</i> |
|----------------------|---------------|--------------------------|--------------|--------------|
| FM-AT01-1010-100E    | A.14          | A.12 (17/09/2008)        | 03/09/2009   | 7 - 11       |



strut to the cantilever arms on the rudder control coupling shaft. That direct linkage of the nose wheel with the rudder control is also active during flight.

The direct linkage between the nose wheel steering and rudder operation allows a swift taxiing, precise taxi manoeuvres and small turn radii, also in crosswind conditions without braking. To gain minimum turn radii, the brakes may be supplementary used as a supportive measure.

### 7.5.2 Main Landing Gear and Brake System

The main landing gear consists of two cantilever struts which act as leaf-springs to absorb the touch-down loads on the undercarriage. The main wheels are equipped with hydraulically actuated disc brakes. The brakes are individually activated on each side by tilting the corresponding rudder pedal in the cockpit backwards with the toe. The actuation of the left and right wheel brake occurs independently of each other by two separate brake circuits.

During the pre-flight check in the cockpit make sure that the feet are well positioned on the combined rudder/toe brake pedals by an adequate seat adjustment to allow full rudder deflection of the pedals while simultaneously applying maximum brakes. Furthermore, make sure that full pedal deflection to each side (full rudder and maximum braking) is not hindered by the firewall or any other attached parts in the direct vicinity.

### 7.5.3 Parking Brake

The parking brake mechanism uses the hydraulic disc brakes and brake circuits of the main landing gear wheels. For this purpose, a manually operated valve locks the applied rudder pedal tilt and hence the applied brake pressures in the left and right wheel brake system when activated.

The parking brake control element is located between the seats in the rear section of the centre pedestal. To set parking brake, the wheel brakes have to be applied with the rudder pedals and, when the desired brake power is achieved, the control element has to be pulled into the lock position and held. After releasing the toe pressure on the pedal tips, the pedals should remain in their tilted position.

To release the parking brake, push down the control knob up to its end stop.

## 7.6 SEATS, SEATBELTS AND HARNESSSES

The seats of the AQUILA AT01 are fabricated from composite materials and are equipped with integrated safety head rests and removable hard-wearing seat cushions.

A stepless fore and aft seat adjustment meets the ergonomic requirements of a wide pilot spectrum. In addition, the seat tracks are inclined upwards in the forward direction

| <i>Document No.:</i> | <i>Issue:</i> | <i>Supersedes Issue:</i> | <i>Date:</i> | <i>Page:</i> |
|----------------------|---------------|--------------------------|--------------|--------------|
| FM-AT01-1010-100E    | A.14          | A.12 (17/09/2008)        | 03/09/2009   | 7 - 12       |

so that smaller pilots will be positioned slightly higher as they adjust the seat forward. An oil/gas spring strut with locking mechanism holds the seat in the adjusted position. The seats as well as the floor panels that cover the control system and other underfloor installed devices and systems may be removed for visual inspections and maintenance.

Both seats are equipped with four-part seat belts with a central rotary buckle. The shoulder harnesses are connected with inertia reel units. While the shoulder harnesses tighten automatically, the lap belts have to be manually tightened at the adjuster buckle. A slight tilting of the adjuster buckle is necessary for the extension of the lap belts. To fasten the seat belts, click each belt fitting successively into the associated receptacles of the rotary buckle until a distinctive “snap” sound is audible to lock them together. The seat belts can be opened by turning the handle of the rotary buckle in the clockwise direction.

### 7.6.1 Seat Adjustment

The seats should be adequately adjusted before the seat belts and shoulder harnesses are fastened. With the seat in the desired position, it has to be verified that all control elements and especially the rudder pedals are well accessible and can be properly operated. To position the seat, a Push Knob has to be pushed to unlock the oil/gas spring strut. The push knob is located underneath the forward edge of the thigh rest of each seat adjacent to the control stick cut-out.

Due to the gas springs of the seat adjustment system in combination with the rolling bearings in the seat track, only small forces are necessary to move the seats into the desired direction. The seats are locked in place by releasing the push knob.

## 7.7 BAGGAGE COMPARTMENT

The AQUILA AT01 incorporates a large baggage compartment behind the seats which can be loaded through a lockable baggage door. The baggage compartment is also accessible through the cabin. To ease the stowing of bulky baggage through the cabin, the seats may be moved in their forward position.

The baggage compartment floor with the exception of a small centre tunnel is equipped with an anti-skid carpet. The maximum permissible load is **40 kilograms**. The weight and centre of gravity limits of the airplane (refer to Section 6 of this handbook) must be observed when loading the airplane. The baggage door must be locked during flight.

Tie-down rings for straps are provided on the floor panels of the baggage compartment to strap down baggage and other payload. Suitable tie-down straps may be purchased

| <i>Document No.:</i> | <i>Issue:</i> | <i>Supersedes Issue:</i> | <i>Date:</i> | <i>Page:</i> |
|----------------------|---------------|--------------------------|--------------|--------------|
| FM-AT01-1010-100E    | A.14          | A.12 (17/09/2008)        | 03/09/2009   | 7 - 13       |

from the manufacturer. For small or loose articles, a baggage net is recommended that is available as spare part.

**CAUTION**

During the pre-flight check, verify that the baggage door is closed and locked.

**CAUTION**

The aircraft mass and centre of gravity position must be within the approved range after the loading of the aircraft is completed.

## 7.8 CANOPY

The big canopy of the AQUILA AT01 offers an excellent all around view. It consists of a rear portion with a window which is bonded into the fuselage structure and a large one-piece acrylic glass dome bonded into a composite frame that can be swivelled forward to open for a comfortable cabin entry. Small sash windows on both sides serve as emergency view windows and can be used for additional cabin ventilation. The canopy is connected to the fuselage at its forward end by a hinge assembly that is attached to the firewall structure. The canopy is rotated upwards around this fixed hinge when opened.

Opening, closing and locking of the canopy can be achieved by a hand lever in the canopy frame which is located on the left side. In case of emergency, this hand lever may also be operated from the right seat. Pulling and turning the hand lever backwards (to the pilot) unlocks the canopy for opening. The reverse action, pushing and turning the lever forward is locking the canopy for flight. From outside the canopy locking mechanism is operated in the same manner but with opposite direction.

To ease the opening and closing of the canopy, a handle located on the inner side of the canopy frame in the centre section of its rearward end above and between the pilots is provided. A gas spring strut provides effective assistance while opening the canopy.

Although the canopy frame and its support as well as the hinge assembly are of stable design, the load on the hinge mechanism and the attachment brackets, however, may become considerably in strong wind conditions due to the size and geometry of the canopy, when it is opened. To prevent an inadvertent closing and damage to the canopy, never leave the canopy open under such conditions. In addition, always secure the canopy by hand while moving the canopy in strong wind conditions.

To evacuate the aircraft in an emergency case, an emergency hammer to smash the acrylic glass is attached to the co-pilot's seat back.

| <i>Document No.:</i> | <i>Issue:</i> | <i>Supersedes Issue:</i> | <i>Date:</i> | <i>Page:</i> |
|----------------------|---------------|--------------------------|--------------|--------------|
| FM-AT01-1010-100E    | A.14          | A.12 (17/09/2008)        | 03/09/2009   | 7 - 14       |



**CAUTION**

When locking the canopy make sure that the canopy frame rests flush on the fuselage. Push the handle on the top of the canopy frame upwards and check the position of the locking handle to make sure that it is locked and can not be unlocked during flight due to vibrations.

## 7.9 POWER PLANT

The AQUILA AT01 is powered by a ROTAX® 912S engine which is a four-stroke cycle engine with four cylinders horizontally opposed. The normal aspirated engine is in standard configuration equipped with a dual breakerless capacitor discharge ignition system and a reduction gearbox with integrated shock absorbers and overload clutch. The engine drives a propeller manufactured by mt-propeller that is controlled by a hydraulic constant speed governor.

The displacement of the engine is 1352 cm<sup>3</sup>, the compression ratio 10.5 : 1. The engine may be operated with AVGAS 100 LL, with unleaded EN 228 Premium and with EN 228 Premium plus fuel. The engine manufacturer recommends the use of unleaded fuels in accordance with EN 228 (MOGAS).

During the installation process into the AQUILA AT01, the maximum engine speed is adjusted to 5500 RPM by limiting the lowest possible propeller pitch setting which results in a propeller speed of 2263 RPM to reduce noise emission level. This RPM-value corresponds to the maximum continuous speed authorized by the engine manufacturer. For the operation of the AQUILA AT01, a maximum continuous power of 69 kilowatt (kW) is available.

Due to the installation of the 2-blade MTV-21-A/175-05 propeller manufactured by mt-Propeller in wood-composite-hybrid design and an especially designed exhaust system, the AQUILA AT01 exhibits an extremely low noise and vibration level. The aircraft has demonstrated a noise level of 64.6 dB(A) which is 7.7 dB(A) below the noise level limit in accordance with the "Noise Requirements for Aircraft" (LSL) Chapter X (refer also to paragraph 5.2.14 of this manual).

The integration of the engine into the fuselage structure is achieved with a frame support designed as a truss which in addition serves as the support of the Nose Landing Gear Strut, the battery as well as miscellaneous engine accessories. The engine is flanged on the frame support with its original ROTAX ring frame support using vibration absorbing Shock-Mounts in the attachment points. The engine frame support itself, in turn, is mounted to the firewall at four attachment points. All engine related loads (engine, gearbox, propeller) and the nose gear loads are transferred into the firewall of the fuselage structure via the described engine suspension arrangement.

| <i>Document No.:</i> | <i>Issue:</i> | <i>Supersedes Issue:</i> | <i>Date:</i> | <i>Page:</i> |
|----------------------|---------------|--------------------------|--------------|--------------|
| FM-AT01-1010-100E    | A.14          | A.12 (17/09/2008)        | 03/09/2009   | 7 - 15       |

### 7.9.1 Engine

The ROTAX® 912S engine is equipped with liquid cooled cylinder heads, ram-air cooled cylinders and a dry sump forced lubrication system. The engine has two carburetors, one for the right cylinders and one for the left cylinders of the engine. For oil and engine coolant cooling, a combined oil cooler/radiator is installed in the front part of the lower engine cowling behind the main cooling air intake. The cooling air baffle for cylinder cooling is connected through a flexible duct with a round air inlet in the front part of the lower engine cowling. The cooling air is discharged out of the engine compartment by an opening at the bottom rear edge of the cowling where also the exhaust end pipe is guided to the exterior of the aircraft.

The exhaust system components are connected through ball joints that are joined with two springs on each side to allow movements due to heat expansion and normal operating loads at the connections and to prevent fatigue fracture due to vibrations.

Carburettor induction air enters the system through a NACA air inlet on the left side of the lower engine cowling and is carried through an air filter box and a flexible duct to the carburettor airbox. The ignition harness of the dual capacitor discharge ignition system is connected through plug connectors (spark plug connectors) to the spark plugs of the cylinders. Each cylinder is equipped with 2 spark plugs which are supplied by different ignition circuits (left and right ignition circuit, refer also to ROTAX Operator's Manual).

The engine coolant is refilled in the expansion tank, located on top of the engine. A transparent overflow bottle, mounted on the right engine side, is connected with the expansion tank by a hose. The overflow bottle is accessible through a service door located on the right side of the upper engine cowling. This service door also allows the checking of the engine oil and coolant levels and their replenishing, if necessary, without removing the engine cowling. These checks are described in Section 4 of this manual, paragraph "Daily Pre-flight Check".

The propeller reduction gearbox includes an integrated torsion shock absorber and an overload clutch. A support is incorporated on the backside of the gearbox housing where the propeller governor is flanged on.

The propeller governor and the reduction gearbox are integrated into the oil circuit of the engine. For this reason, the engine oil must fulfil a series of specific characteristics. The use of semi- or full synthetic oils for four-stroke motor cycle engines classified according to the API-system as "SG" or higher with gearbox additives and a wide temperature range is recommended. Friction modifier additives must not be contained in the oil as this could result in an undue slipping of the overload clutch during normal operation. Never use aviation grade engine oil or diesel engine oil. For complete information regarding engine oil and oil change intervals, refer to ROTAX® Operator's Manual and to the ROTAX® Service Instruction SI-912-016.

| <i>Document No.:</i> | <i>Issue:</i> | <i>Supersedes Issue:</i> | <i>Date:</i> | <i>Page:</i> |
|----------------------|---------------|--------------------------|--------------|--------------|
| FM-AT01-1010-100E    | A.14          | A.12 (17/09/2008)        | 03/09/2009   | 7 - 16       |

**CAUTION**

The specifications for operating fluids issued by ROTAX® Aircraft Engines Inc. for the 912S engine must be adhered to.

**CAUTION**

Before every takeoff, a functional check of both ignition circuits must be performed.  
For more information on the engine, refer to ROTAX® Operator's Manual.

### 7.9.2 Throttle and Choke

The throttle control lever is well accessible for both, the pilot as well as the co-pilot, located in the front section of the centre pedestal adjacent to the left of the propeller control lever (blue star-shaped knob). During throttle lever operation, the throttle valves of both carburettors are actuated synchronously by two bowden cables.

For full engine power (max. manifold pressure), both, the throttle and the propeller control lever, should be placed in full forward position. Idle power is adjusted by moving the throttle lever to the full aft position.

The starting carburettor is actuated by pulling the control element for the choke which is located on the control panel below the midsection of the instrument panel adjacent to the control elements for the carburettor and cabin heat. When the choke is activated, the starting carburettor enriches the fuel mixture for the start-up of the cold engine. The starting carburettor is only operating if the throttle lever is in the IDLE position.

The choke should only be used for a short period of time during the start-up of the cold engines. After releasing, the spring loaded control knob returns automatically into the OFF position.

**CAUTION**

During the daily pre-flight check, verify that the throttle and starting carburettor control arms are able to reach their stops.

Before every takeoff, check if the choke control element has completely returned into its OFF position.

| <i>Document No.:</i> | <i>Issue:</i> | <i>Supersedes Issue:</i> | <i>Date:</i> | <i>Page:</i> |
|----------------------|---------------|--------------------------|--------------|--------------|
| FM-AT01-1010-100E    | A.14          | A.12 (17/09/2008)        | 03/09/2009   | 7 - 17       |

### 7.9.3 Propeller and Propeller Control

The AQUILA AT01 is equipped with a two-blade hydraulically controlled variable pitch propeller (constant speed propeller) in wood-composite-hybrid design for thrust generation. The propeller blades are constructed with a wooden core covered by glass fibre reinforced epoxy layers and are equipped with a stainless steel leading edge protection in the outer section of the blade and in the inner section with a self-adhesive PU-strip.

The adjustment of the propeller blade pitch is accomplished by a hydraulically operated propeller governor that increases the pitch against a spring load. The oil-hydraulic governor keeps the pre-selected propeller speed at a constant value regardless of manifold pressure and airspeed (constant-speed-control). In the case of oil pressure loss, the blades will be automatically set into lowest pitch position. This ensures the further availability of full power. A feathering system is not provided in this type of propeller.

The propeller speed is selected by the propeller control lever that is located in view of the pilot and well accessible in the front section of the centre pedestal adjacent to the ride side of the throttle lever. Lowest pitch and highest propeller speed is adjusted by moving the control lever into the full forward position. With the control lever in this position in combination with the throttle fully opened, maximum engine power is obtained which is normally required during take-off and initial climb. In the final approach for landing, the low pitch setting is also used in order to increase the propeller drag force with low power setting and to have full climb power in case of a missed approach. During the climb and cruise segment, the manifold pressure (throttle position) and the propeller pitch are normally adjusted on each other. Refer to Section 5 of this manual and to ROTAX® 912S Operator's Manual for more information.

|                |
|----------------|
| <b>CAUTION</b> |
|----------------|

Prior to every take-off, the propeller control lever should be continuously switched between the end positions several times. Besides of transferring oil into the governor while simultaneously conducting a functional checking of the system, an additional flushing of the governor is achieved during this procedure to avoid the formation of deposits (e.g. lead contained in the fuel).

### 7.9.4 Carburettor Heat

The Carburettor heat system supplies the carburettors with preheated air. The carburettor heat push-pull type control element is located on the control panel below the midsection of the instrument panel adjacent to the control elements for the Choke and Cabin Heat actuation. By pulling the carburettor heat control element, two coupled flap

| <i>Document No.:</i> | <i>Issue:</i> | <i>Supersedes Issue:</i> | <i>Date:</i> | <i>Page:</i> |
|----------------------|---------------|--------------------------|--------------|--------------|
| FM-AT01-1010-100E    | A.14          | A.12 (17/09/2008)        | 03/09/2009   | 7 - 18       |

valves in the air inlet duct of the airbox are actuated which stop the direct air supply from the air intake and simultaneously open the supply of preheated air from the exhaust muffler area to enter the carburettors. The correct use of carburettor heat prevents the forming of carburettor ice that may cause rough engine operation culminating in a total engine failure in the worst case. If carburettor icing is already encountered, it normally can be slowly removed by activating the carburettor heat and, at the same time, the engine power setting isn't changed.

Carburettor heat must be used in accordance with the common rules and procedures.

A carburettor heat functional check has to be performed during every pre-flight check. After engaging the carburettor heat at a Propeller Speed of 1700 RPM, the RPM drop should be at least 20 – 50 RPM.

|                |
|----------------|
| <b>CAUTION</b> |
|----------------|

The activated Carburettor Heat reduces the engine power.

## 7.10 FUEL SYSTEM

The AQUILA AT01 is equipped with a drainable integral fuel tank in each wing. The fuel capacity of each tank is approximately 60 Litres, the unusable fuel portion is 5.2 Litres per tank.

The fuel tanks are located in the inboard third of each wing half, forward of the main spar. Each fuel tank is confined by the upper and lower wing skin structure which is reinforced and specially sealed in this area, the wing spar as well as the inboard and outboard fuel tank rib on each span-wise side. Each fuel tank is furnished with a lockable fuel filler cap unit which is bonded into the wing structure flush with the upper wing skin. Both fuel filler cap units are grounded to the airframe.

The fuel supply of the carburettors is accomplished by the engine driven mechanical fuel pump from the fuel tank that is pre-selected at the fuel selector/shut-off valve. An additional electrical fuel pump is provided as a backup system in case of the failure of the engine driven fuel pump or for situations where the supplied fuel pressure is too low. Excess fuel flows back to the pre-selected fuel tank through return lines and the fuel selector/shut-off valve. The fuel return line is connected to the inboard fuel tank rib of each fuel tank.

Low fuel pressure in the fuel supply lines of the carburettors (below 0.15 bar / 2.2 PSI) is detected by a fuel pressure sensor and indicated on the instrument panel by a red warning light. In the case of too low fuel pressure, the electrical fuel pump has to be engaged as well.

The fuel system schematic is shown on the next page.

| <i>Document No.:</i> | <i>Issue:</i> | <i>Supersedes Issue:</i> | <i>Date:</i> | <i>Page:</i> |
|----------------------|---------------|--------------------------|--------------|--------------|
| FM-AT01-1010-100E    | A.14          | A.12 (17/09/2008)        | 03/09/2009   | 7 - 19       |

**CAUTION**

The electrical fuel pump must be switch on during all take-offs and landings as well as in those cases where too low fuel pressure is indicated by the fuel pressure warning light.

**Fuel System Schematic**

- 1 NN
- 2 Drain-Valve
- 3 Coarse Fuel Filter Element
- 4 Fuel Strainer
- 5 Electrical Fuel Pump
- 6 Fuel Selector/Shut-Off Valve
- 7 Engine Driven Mechanical Fuel Pump
- 8 Carburettor
- 9 Fuel Pressure Warning Light
- 10 Dual Fuel Level Indicator
- 11 Fuel Filler
- 12 Firewall
- 13 Engine
- 14 Fuel Return Line
- 15 Capacitive Fuel Level Probe
- 16 Fuel Distributor on engine side
- 17 Fuel Supply Line

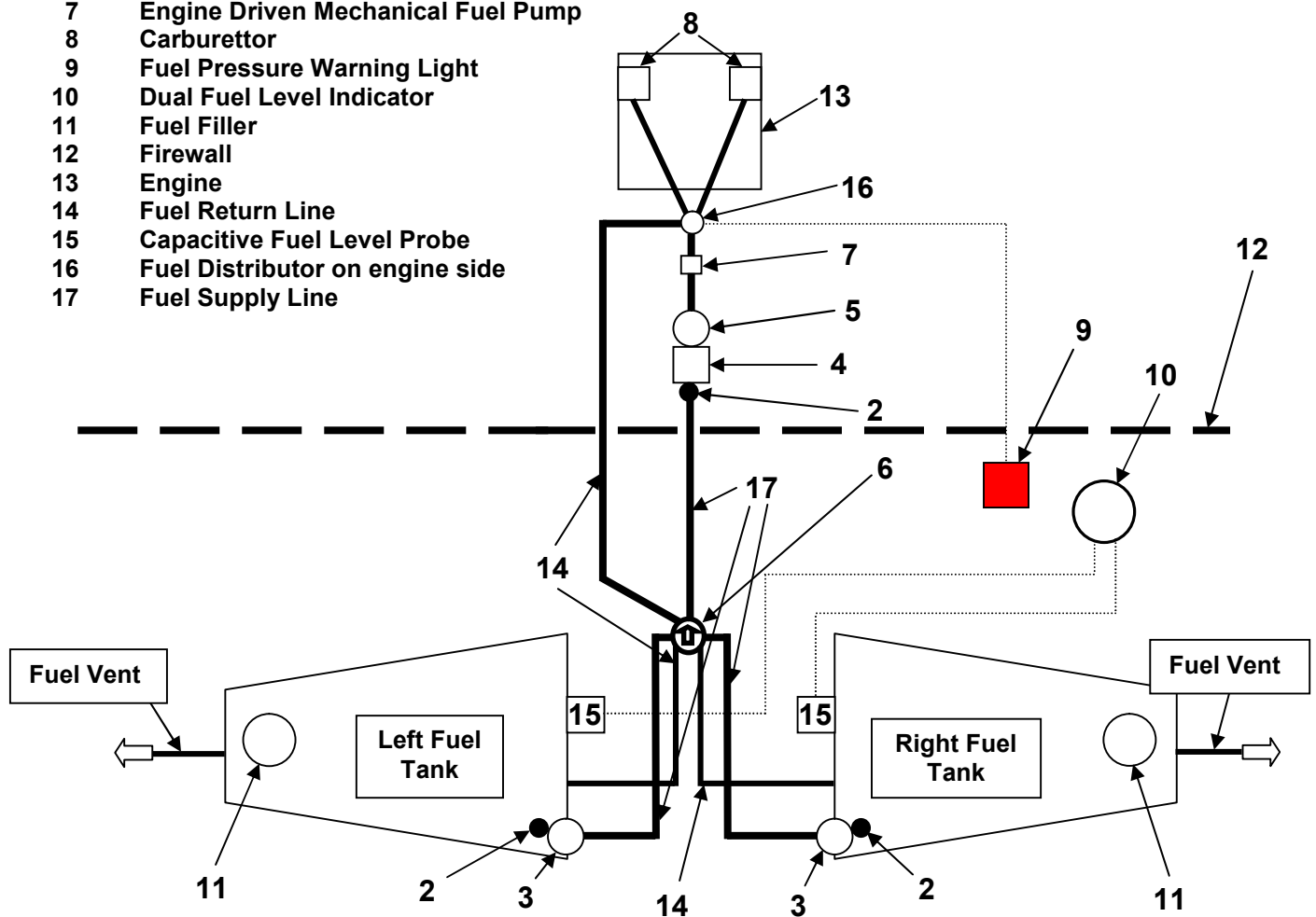

| Document No.:     | Issue: | Supersedes Issue: | Date:      | Page:  |
|-------------------|--------|-------------------|------------|--------|
| FM-AT01-1010-100E | A.14   | A.12 (17/09/2008) | 03/09/2009 | 7 - 20 |

### 7.10.1 Fuel Storage and Ventilation

The inner surfaces of the composite integral tanks are coated with a special fuel tank sealant to protect the fibre composite structure against decomposition. To dampen, harmonize and smooth the fuel motion in the fuel supply outlet nozzle and fuel probe area, an anti-sloshing baffle with special perforation is integrated into the fuel tanks near the fuel supply outlet.

The fuel tanks are vented at the topmost point of each fuel tank through a vent line that is connected to the fuel tank at the upper edge of the outboard fuel tank rib and is guided through the outboard section of the wing to the vent line outlet located in the winglets.

The fuel supply outlet nozzle of each tank, which is equipped with a removable coarse fuel filter element, is located in the lower rearward corner of the inboard fuel tank rib above the fuel sump level. From this outlet nozzle, the fuel flows in the fuel supply lines through the Fuel Selector/Shut-Off Valve located in the fuselage below the centre pedestal, the electrical fuel pump that is attached to the firewall adjacent to its lower edge, the engine driven mechanical fuel pump and the fuel distributor to the float chambers of the carburetors. Fuel that is supplied in excess returns from the fuel distributor in Fuel Return Lines through the Fuel Selector/Shut-off Valve back into the pre-selected fuel tank.

The installations in the inboard fuel tank ribs are well accessible for maintenance through an access opening on the lower wing surface.

Each fuel tank is equipped with an individual manually operated drain valve located at the lowest point of the fuel tank sump to check the fuel for water and deposits during pre-flight checks. A further drain valve is installed at the lowest point of the entire fuel system which is at the outlet of the electrical fuel pump. This drain valve is accessible at the bottom of the fuselage in front of the firewall.

### 7.10.2 Fuel Selector / Shut-Off Valve

For the selection of the fuel tank and to interrupt the fuel supply in the case of an emergency, a Fuel Selector/Shut-off Valve is provided within the fuel system. The selector handle is mounted well accessible and well visible for both pilots on the centre pedestal between the seats (see also the picture on page 7-10).

The red, arrow shaped handle has a LEFT, RIGHT, and OFF-position. Each position has a positive detent and is self-actuating centred in its switch setting by a spring-loaded pin. To switch the valve into the OFF-position, a knob located at the top of the handle must be pulled simultaneously while turning the handle clockwise into the OFF-position. With the valve in this position which is indicated by the selector pointing in the right rearward diagonal direction, the fuel flow in the supply and return lines is interrupted.

| <i>Document No.:</i> | <i>Issue:</i> | <i>Supersedes Issue:</i> | <i>Date:</i> | <i>Page:</i> |
|----------------------|---------------|--------------------------|--------------|--------------|
| FM-AT01-1010-100E    | A.14          | A.12 (17/09/2008)        | 03/09/2009   | 7 - 21       |



In both normal operating positions (LEFT/RIGHT), the fuel supply and corresponding return line of the selected fuel tank are opened, whereas the fuel supply and return line of the other fuel tank are closed. The valve-handle points towards the direction of the fuel tank being selected.

It is recommended to keep the fuel level in both tanks approximately on same levels. For this reason, a switch-over from one tank to the other should be performed in an hourly interval.

### 7.10.3 Electrical Fuel Pump and Fuel Strainer

The electrical fuel pump is incorporated into the fuel system without a bypass line. In this arrangement, the fuel passes through the electrical fuel pump and a fuel strainer element integrated into its housing even if the electrical fuel pump is switched off. This fuel strainer element is replaceable when the housing of the electrical fuel pump is disassembled.

The electrical fuel pump is installed inside the engine compartment attached to the firewall near its lower edge. Below the electrical fuel pump, the lowest point of the entire fuel system, a fuel drain valve is provided for the drainage of water and deposits from the fuel system. The drain valve is accessible at the lower surface of the fuselage bottom adjacent to the firewall section. A further filter element is integrated into the engine driven mechanical fuel pump which is only renewable by replacing the entire fuel pump unit.

The 12 VDC electrical power supply for the electrical fuel pump is provided by the main electrical bus. The operation of the electrical fuel pump can be controlled by a rocker switch located in the row of switches in the lower left section of the instrument panel. During all take-offs, landings and other critical flight phases as well as in those cases where too low fuel pressure is indicated, the electrical fuel pump has to be switched ON. The proper function of the pump motor can be identified on ground by the distinctive "ticking" sound when the fuel pump is activated. Refer also to Section 4.4 "Pre-flight Inspections" of this manual for more details.

### 7.10.4 Fuel Level Indication

A Capacitance fuel level probe installed in the inboard fuel tank rib of each fuel tank generates and transmits an electrical signal, depending on the fuel level in the tank, to a dual fuel level indicator located in the right section of the instrument panel. The fuel level indicator has the markings FULL,  $\frac{3}{4}$ ,  $\frac{1}{2}$ ,  $\frac{1}{4}$ , and EMPTY for each tank. The fuel level indication is calibrated and adjusted on the basis of the actual fuel tank content after its installation. Through access openings located on the lower wing surface the fuel probes are well accessible for readjustment, maintenance or replacement.

The aircraft attitude has only a minor effect on the well readable fuel level indication. However, measuring systems never work without error and must be accepted as not safe in the absence of redundancies because of possible defects. Therefore, a marked

| <i>Document No.:</i> | <i>Issue:</i> | <i>Supersedes Issue:</i> | <i>Date:</i> | <i>Page:</i> |
|----------------------|---------------|--------------------------|--------------|--------------|
| FM-AT01-1010-100E    | A.14          | A.12 (17/09/2008)        | 03/09/2009   | 7 - 22       |



dipstick for verifying the fuel level manually is delivered with the aircraft. With the aircraft in a horizontally and laterally level position, the dip-stick should be perpendicularly inserted into the fuel tank in such a way that the handle of the dipstick is completely seated on the upper surface of the wing. After pulling the dipstick out of the fuel tank, the fuel level can be determined by the “wetted” area of the dipstick in comparison with the respective engraved markings and may be compared with the electrical fuel level indication on the instrument in the cockpit. This check has to be performed at least during every daily pre-flight check. For this reason, the dip-stick should always be carried in the aircraft. It is stowed at the inboard side of the baggage compartment door.

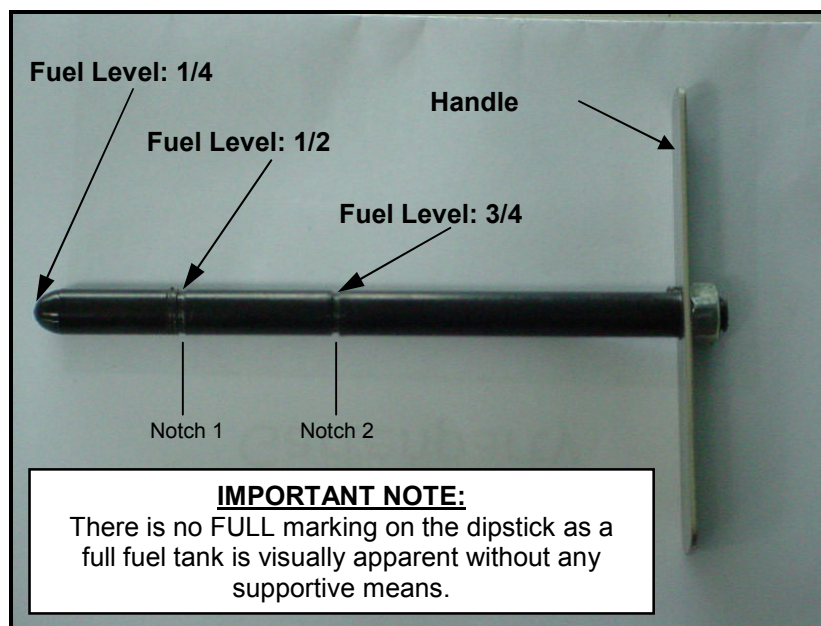

**CAUTION**

The fuel level indication on the instrument has to be cross-checked with the fuel dipstick daily. For that, level out the aircraft horizontally and laterally as much as possible. The dipstick markings show  $\frac{1}{2}$  and  $\frac{3}{4}$  of the maximum fuel tank content.

**CAUTION**

During the refuelling, the aircraft must be electrically grounded at the marked grounding point (outlet of the exhaust tail pipe, refer also to placard 39 pg. 2-17).

**7.10.5 Fuel Tank Drainage System**

Each fuel tank is equipped with its own, manually operated, drain valve at the lowest point of the fuel tank located in the inboard rear corner adjacent to the tank rib. A further drain valve is installed at the lowest point of the entire fuel system which is located at

| <i>Document No.:</i> | <i>Issue:</i> | <i>Supersedes Issue:</i> | <i>Date:</i> | <i>Page:</i> |
|----------------------|---------------|--------------------------|--------------|--------------|
| FM-AT01-1010-100E    | A.14          | A.12 (17/09/2008)        | 03/09/2009   | 7 - 23       |

the base of the electrical fuel pump. This drain valve is accessible at the lower surface of the nose section without the removal of any components.

The attachment clip for the fuel sample cup is located at the inboard side of the baggage compartment door.

|                |
|----------------|
| <b>CAUTION</b> |
|----------------|

The check of the fuel sump for water and deposits has to be performed during every daily pre-flight inspection. Samples have to be taken at all three drain valves BEFORE the aircraft is moved and hence the fuel sump intermixed.

## 7.11 ELECTRICAL SYSTEM

The AT01 is equipped with a 12 V direct current (DC) electrical system that is powered by an engine driven alternator and a battery. The electrical equipment is operated and controlled by rocker switches which are located on the lower left section of the instrument panel provided that the red "ALT/BAT"-Master Switch is engaged. All electrical circuits are protected with circuit breakers which are all well accessibly arranged in the right section of the instrument panel.

The control and operation of the engine ignition system as well as the tachometer work completely independent of the aircraft power supply system.

### 7.11.1 Power Supply and Battery System

The 12 V lead-acid battery with a capacity of 19 Ah (Moll or Varta LF 12V, respectively), 28 Ah (Licence CTX30L) or 30 Ah (Multipower MP30/12C), depending of the installed option, is connected to the electrical system of the aircraft via a 50-amp circuit breaker and the red BAT-Switch. With engine operating, the battery is charged by a 40-amp alternator that is equipped with an internal regulator and protected by the 50-amp alternator circuit breaker. The air-cooled alternator is driven via V-belt drive geared down from the propeller shaft.

In the case of insufficient charging by the alternator, the "Alternator" warning light located in the upper mid-section of the instrument panel will illuminate. In addition, an ammeter and voltmeter are installed in the right section of the instrument panel for monitoring the battery charging rate and its charging condition.

In the event of an alternator failure, the battery is able to supply the complete electrical system with all electrical accessories for at least half an hour provided that it is correctly maintained and in a good condition.

| <i>Document No.:</i> | <i>Issue:</i> | <i>Supersedes Issue:</i> | <i>Date:</i> | <i>Page:</i> |
|----------------------|---------------|--------------------------|--------------|--------------|
| FM-AT01-1010-100E    | A.14          | A.12 (17/09/2008)        | 03/09/2009   | 7 - 24       |

### 7.11.2 Ignition System and Starter

The engine is equipped with an electronically controlled ignition system of a breakerless capacitor discharge design that has two separate ignition circuits which are independent of each other. The ignition system needs no external power supply and is activated by the ignition switch. The internal control unit interrupts the ignition if the propeller speed is below 100 RPM.

The ignition switch is operated clockwise from the OFF-Position via the R, L, BOTH positions into the START-Position. When the switch is turned into the spring loaded START-Position the engine starter is activated and cranks the engine. When the switch is released, it will automatically return to the BOTH-Position and the engine starter is deactivated. The BOTH-Position is the setting for normal operation with both ignition circuit activated and hence both spark plugs in each cylinder operating.

With the positions R and L selected, one of the two ignition circuits is deactivated which is the case during the functional check of the ignition system. With a propeller speed of 1700 RPM the RPM-drop on either magneto should not exceed 120 RPM and the difference between the L and R settings should not exceed 50 RPM.

Further information for engine operation and pre-flight checks are contained in the Operator's Manual for all versions of ROTAX® 912 engines.

| <i>Document No.:</i> | <i>Issue:</i> | <i>Supersedes Issue:</i> | <i>Date:</i> | <i>Page:</i> |
|----------------------|---------------|--------------------------|--------------|--------------|
| FM-AT01-1010-100E    | A.14          | A.12 (17/09/2008)        | 03/09/2009   | 7 - 25       |

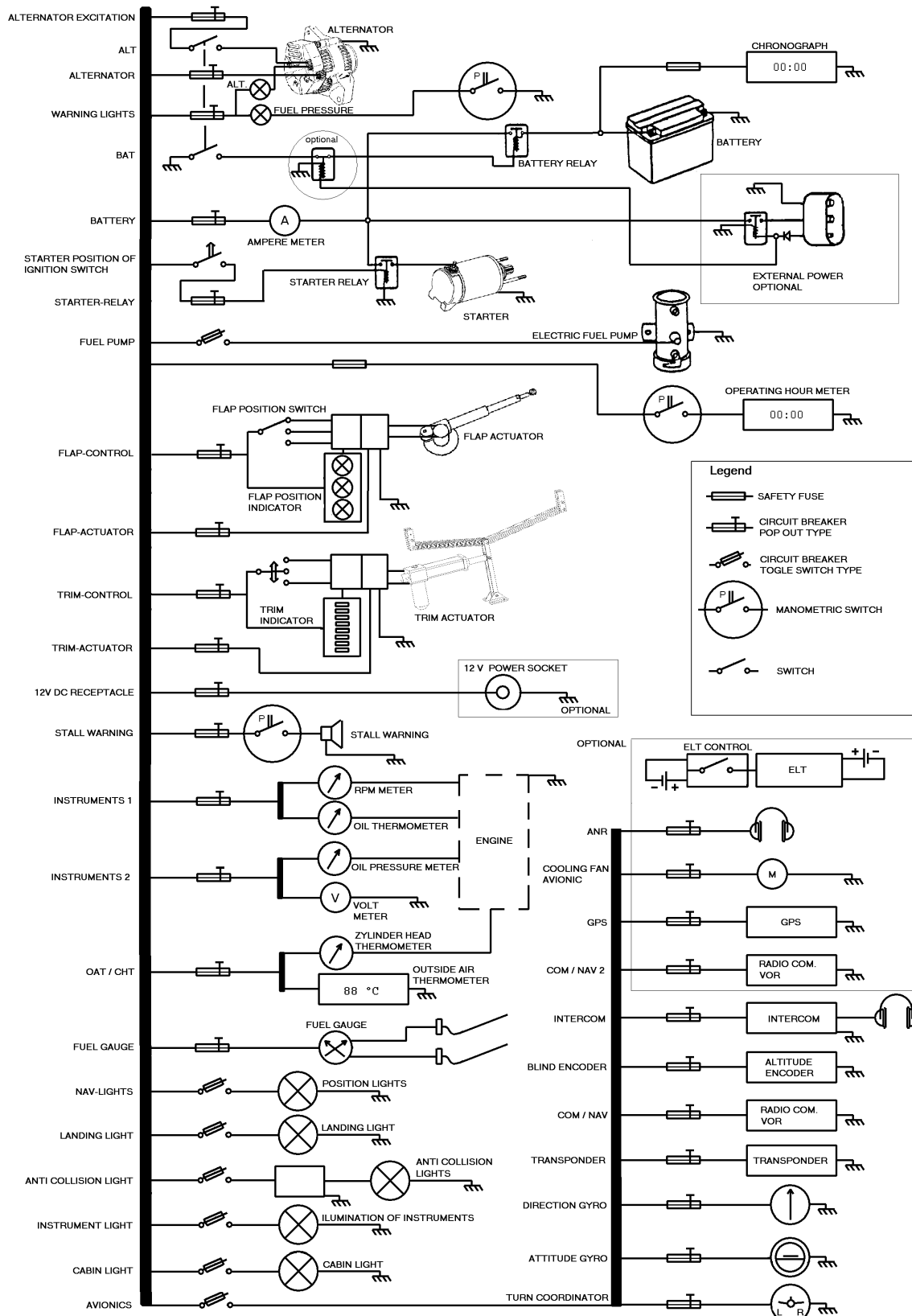

Fig.: Electrical System Schematic

| Document No.:     | Issue: | Supersedes Issue: | Date:      | Page:  |
|-------------------|--------|-------------------|------------|--------|
| FM-AT01-1010-100E | A.14   | A.12 (17/09/2008) | 03/09/2009 | 7 - 26 |

### 7.11.3 Electrical Equipment and Circuit Breakers

All electrical equipment may be separately turned on or off by circuit breakers of push-pull type or by rocker switches with built-in circuit breaker function.

NAV/COM-equipment as well as other avionic equipment is supplied with electrical power via the avionic master switch and the avionic main bus and is protected with separate circuit breakers. For each electrical system that must be turned on and off several times during normal operation (electrical fuel pump, anti-collision lights etc.), a separate rocker switch located in the lower left section of the instrument panel is provided for their operation. The circuit breakers for all other electrical equipment are located in the right section of the instrument panel (refer also to the figure on page 7-9).

### 7.11.4 Voltmeter and Ammeter

The voltmeter shows the system voltage generated by the power sources.

The voltmeter indication scale is subdivided into three different coloured voltage ranges:

|                            |        |      |
|----------------------------|--------|------|
| Red Arc                    | 8-11.0 | Volt |
| Red-green crosshatched Arc | 11-12  | Volt |
| Green Arc                  | 12-15  | Volt |
| Red line                   | 15-16  | Volt |

The ammeter indicates the amount of current flow, in amperes, from the alternator to the battery or from the battery to the electrical system of the aircraft, depending on the algebraic sign of the indication. An indication in the (+)-range of the instrument scale displays the charging current to the battery, whereas an indication in the (-)-range of the instrument scale shows the discharging current of the battery. This means that the battery is supplying the electrical system of the aircraft and might be a sign of an alternator malfunction if such an indication occurs during normal engine operating conditions.

### 7.11.5 Alternator Warning Light

The red alternator warning light does not illuminate during normal operation.

The warning light will illuminate only if:

- An alternator failure (Loss of external alternator output) occurs

In these cases, all electrical power is supplied solely by the battery.

This does not affect the operation of the engine ignition system because it depends exclusively on the function of the engine internal generator.

| <i>Document No.:</i> | <i>Issue:</i> | <i>Supersedes Issue:</i> | <i>Date:</i> | <i>Page:</i> |
|----------------------|---------------|--------------------------|--------------|--------------|
| FM-AT01-1010-100E    | A.14          | A.12 (17/09/2008)        | 03/09/2009   | 7 - 27       |

### 7.11.6 Fuel Pressure Warning Light

If the fuel pressure at the fuel distributor in the fuel supply line to the carburettors drops below 0.15 bar, a pressure-controlled switch activates the red fuel pressure warning light located in the upper mid-section of the instrument panel.

Probable causes may be:

- insufficient fuel supply;
- Fuel vapour in the system.

### 7.11.7 Engine Instruments and Fuel Level Indicator

Cylinder head temperature and oil temperature as well as oil pressure are indicated on analogue pointer instruments. These instruments receive their electrical signals from resistance-type probes located in the engine, and translate them in appropriate readings.

The analogue dual fuel level indicator receives its measuring signals by two capacitance-type fuel level probes, one in each tank.

### 7.11.8 External Power Unit

It is recommended to use an External Power Unit (EPU) for engine start-up at outside air temperatures below  $-10^{\circ}$  C. The EPU receptacle and the related circuits which are both optionally installed provide the opportunity to connect an external power source to the aircraft for engine start-up. The receptacle is mounted on the right fuselage side below the battery. Access is provided by a service door in the lower cowling.

Electrical power for the engine starter and the electrical buses is provided via a three pole receptacle with protection for reverse polarity by a relay circuit. A second relay is disconnecting the on-board battery as long as the external power source is connected to the aircraft. This second relay prevents an uncontrolled charging or discharging of the battery during the EPU operation.

**WARNING**

Before starting the engine with external power, make sure that **NO** persons or objects are near the propeller disk area.

Procedure for starting up the engine with an external power source:

1. Plug in the external power source at the receptacle
2. ALT/BAT switch ON
3. Engine Start-up (in accordance with paragraph 4.5.2 "Engine Start-up")
4. Disconnect external power source

| <i>Document No.:</i> | <i>Issue:</i> | <i>Supersedes Issue:</i> | <i>Date:</i> | <i>Page:</i> |
|----------------------|---------------|--------------------------|--------------|--------------|
| FM-AT01-1010-100E    | A.14          | A.12 (17/09/2008)        | 03/09/2009   | 7 - 28       |

## 7.12 PITOT-STATIC SYSTEM

Total and Static Pressure are taken from a pitot-static tube installed on the lower surface of the left wing and are transferred through the interior of the wing to the wing-body intersection by total and static pressure lines. At the wing-body-joint, the pressure lines are connected to water separators and disconnection couplings to enable a simple and easy demounting of the wing.

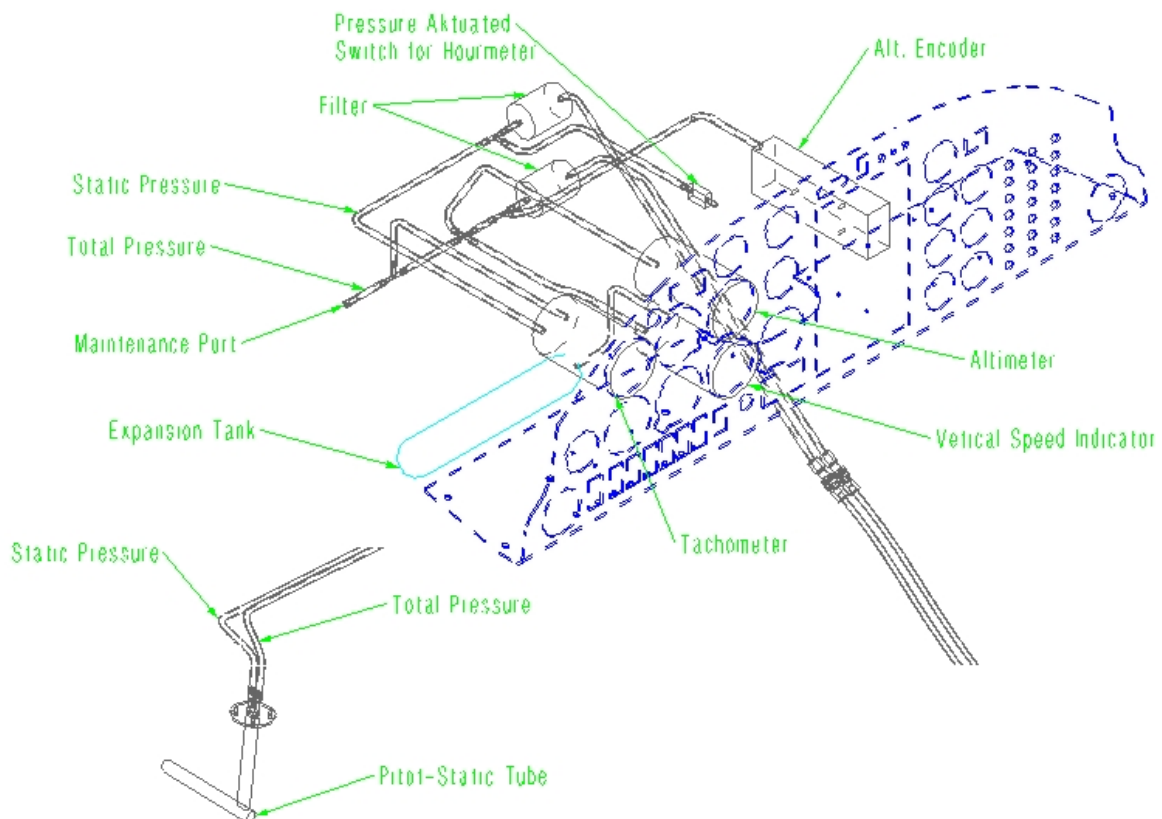

Figure: Pitot-Static System Schematic

Another disconnection point for the pressure lines is provided behind the instrument panel at the location of the dust filters. Behind the disconnection point and the dust filters, the total pressure line is connected to the airspeed indicator and the static pressure line is distributed using tee connectors to supply the airspeed indicator, the altimeter, the vertical speed indicator and the altitude blind encoder with static pressure.

The vertical speed indicator is additionally connected via a pressure line to an expansion tank that is installed below the cockpit floor panel.

| Document No.:     | Issue: | Supersedes Issue: | Date:      | Page:  |
|-------------------|--------|-------------------|------------|--------|
| FM-AT01-1010-100E | A.14   | A.12 (17/09/2008) | 03/09/2009 | 7 - 29 |



The pitot-static system error may be ignored for the altitude measurement. An airspeed calibration chart is provided in Section 5 of this manual.

While the aircraft is parked on the ground, the pitot-static tube cover delivered with the aircraft and labelled with the tag "Remove Before Flight" should always be placed over the pitot-static tube to prevent insects, water and dirt entering and clogging the orifices of the pitot-static tube.

If erroneous instrument readings are suspected, an inspection of the pitot-static system for obstructions, damages, clogging (water, foreign objects, damaged pressure lines etc.) and leakage must be performed. A defective instrument is rather rarely the cause.

|                |
|----------------|
| <b>CAUTION</b> |
|----------------|

During daily pre-flight inspection, the pitot-static tube cover must be removed, and a system check should be conducted. For this purpose, a person may momentarily blow into the direction of the pitot-static tube from a distance of approximately 10 cm. A second person has to monitor the indication of the appropriate instruments (airspeed indicator, altimeter, vertical speed indicator) in the cockpit for associated pointer deflections.

During the pre-flight check, verify the pitot-static tube cover is removed from the tube.

### 7.13 STALL WARNING SYSTEM

An approach to stalling condition at 1.1 times the stalling speed is indicated for all flap settings by a loud audible alarm signal.

As the aircraft approaches stalling condition, a switch in the sensor unit is activated due to the change in airflow and local pressure distribution at the wing leading edge with increasing angle-of-attack. The airflow deflects a micro plate in the sensor upwards closing a mechanical contact and a circuit which sends an electrical signal to the warning buzzer in the cockpit. The warning buzzer generates an alarm signal as long as the stalling situation and the corresponding flight condition is maintained.

|                |
|----------------|
| <b>CAUTION</b> |
|----------------|

The stall warning sensor is sensitive to excessive splash water and mechanical damages. Be careful when cleaning the wing in the vicinity of the stall warning sensor to prevent damage to the stall warning system especially due to excessive water exposure.

| <i>Document No.:</i> | <i>Issue:</i> | <i>Supersedes Issue:</i> | <i>Date:</i> | <i>Page:</i> |
|----------------------|---------------|--------------------------|--------------|--------------|
| FM-AT01-1010-100E    | A.14          | A.12 (17/09/2008)        | 03/09/2009   | 7 - 30       |



## 7.14 AVIONICS

Depending on the installed optional avionic equipment, a NAV/COM Transceiver, a Transponder or a Multi-functional Display might be located in the centre section of the instrument panel. Detailed information on the operation of this equipment and descriptions of its systems are provided in the associated Airplane Flight Manual Supplements in Section 9.

The COM Transmitter is activated by a push-to-talk button which is integrated into each control stick. The microphone and headphone jacks are located in the rear section of the centre pedestal between the seats.

| <i>Document No.:</i> | <i>Issue:</i> | <i>Supersedes Issue:</i> | <i>Date:</i> | <i>Page:</i> |
|----------------------|---------------|--------------------------|--------------|--------------|
| FM-AT01-1010-100E    | A.14          | A.12 (17/09/2008)        | 03/09/2009   | 7 - 31       |

**7.15 RESERVED**

[Intentionally left blank]

| <i>Document No.:</i> | <i>Issue:</i> | <i>Supersedes Issue:</i> | <i>Date:</i> | <i>Page:</i> |
|----------------------|---------------|--------------------------|--------------|--------------|
| FM-AT01-1010-100E    | A.14          | A.12 (17/09/2008)        | 03/09/2009   | 7 - 32       |

## SECTION 8 HANDLING, SERVICE & MAINTENANCE

|       |   | Page |
|-------|---|------|
| 8.1   | INTRODUCTION  | 8-2  |
| 8.2   | AIRCRAFT INSPECTION PERIODS                             | 8-2  |
| 8.3   | MODIFICATIONS AND REPAIRS                               | 8-2  |
| 8.4   | GROUND HANDLING AND ROAD TRANSPORTATION OF THE AIRCRAFT | 8-3  |
| 8.4.1 | Towing  | 8-3  |
| 8.4.2 | Parking   | 8-3  |
| 8.4.3 | Tie-Down  | 8-4  |
| 8.4.4 | Jacking   | 8-4  |
| 8.4.5 | Road Transportation                                     | 8-4  |
| 8.5   | CLEANING AND CARE                                       | 8-6  |
| 8.5.1 | Painted Surfaces  | 8-6  |
| 8.5.2 | Canopy  | 8-7  |
| 8.5.3 | Propeller   | 8-7  |
| 8.5.4 | Engine  | 8-8  |
| 8.5.5 | Interior Cleaning                                       | 8-8  |

| <i>Document No.:</i> | <i>Issue:</i> | <i>Supersedes Issue:</i> | <i>Date:</i> | <i>Page:</i> |
|----------------------|---------------|--------------------------|--------------|--------------|
| FM-AT01-1010-100E    | A.12          | A.01 (05/06/2002)        | 17/09/2008   | 8 - 1        |

## 8.1 INTRODUCTION

Section 8 contains factory recommended procedures for correct ground handling as well as information regarding care instructions and servicing of the AQUILA AT01.

Furthermore, it also includes requirements which must be adhered to during inspection as well as maintenance and when implementing modifications and repairs.

## 8.2 AIRCRAFT INSPECTION PERIODS

A mandatory inspection must be conducted every 100 hours of aircraft operation. The required inspection items are listed and described in the AQUILA AT01 Maintenance Manual as well as the Maintenance Manual of the ROTAX® engine type 912 series and the mt-propeller Operation and Installation Manual.

After the first 25 hours of operation of a newly delivered aircraft, a one-time special inspection with the extent of a 100-hour inspection has to be conducted.

After the first 25 hours of operation of a newly supplied or overhauled engine, the one-time special inspection of the engine must be conducted as well.

|                |
|----------------|
| <b>CAUTION</b> |
|----------------|

If the engine is mainly operated with AVGAS, the oil change interval is reduced to 50 hours (refer also to section 1.8 or the Operators Manual for ROTAX® Engine Type 912 Series, latest revision, for more information).

## 8.3 MODIFICATIONS AND REPAIRS

Prior to any modifications implemented into the aircraft, the approval of the Agency or the respective National Aviation Authority, if outside the EU, must be obtained to ensure that the airworthiness of the aircraft is not adversely affected. The regulation of the EASA or national aviation regulations, respectively, have to be observed in this regard.

Any maintenance and repair should be accomplished in accordance with the instructions contained in the effective AQUILA AT01 Maintenance Manual as well as in Service Bulletins and Service Information, where applicable.

Prior to major repairs as well as in all cases of damages to the aircraft where the cause is unknown or suspect, the aircraft manufacturer or TC holder should be contacted.

| <i>Document No.:</i> | <i>Issue:</i> | <i>Supersedes Issue:</i> | <i>Date:</i> | <i>Page:</i> |
|----------------------|---------------|--------------------------|--------------|--------------|
| FM-AT01-1010-100E    | A.12          | A.01 (05/06/2002)        | 17/09/2008   | 8 - 2        |

## **8.4 GROUND HANDLING AND ROAD TRANSPORTATION OF THE AIRCRAFT**

### **8.4.1 Towing**

#### **8.4.1.1 Forward Movement**

The aircraft can be safely moved and controlled by one person on a smooth and level surface using the tow bar delivered together with the aircraft. Before attaching the tow bar to the nose wheel of the aircraft, make sure that the propeller blades are oriented near their horizontal position. When the aircraft is parked, the tow bar should be removed from the aircraft.

#### **8.4.1.2 Backward Movement**

For backward movements of the aircraft the tow bar should also be preferably used. For this purpose, the tow bar is used to push and control the aircraft. To hold direction, locate an aim in a line with the aircraft tail and try to correct deviations while pushing the aircraft. Helpers may push the aircraft at the wing leading edge near the fuselage. The aircraft may also be pushed on the propeller blades but only in a region near the spinner. Never push or pull the aircraft in the region of the propeller tips.

#### **8.4.1.3 Turning the Aircraft on the Ground**

To turn the aircraft on ground, if area is limited to manoeuvre the aircraft, use the following procedure. Only one person is necessary.

Press down the tail-boom of the aircraft in front of the vertical stabilizer to raise the nose wheel off the ground. With the nose wheel off the ground, the aircraft may be turned by pivoting it around an axis between the main wheels. Never press on the horizontal stabilizer to raise the nose wheel off the ground. The structural integrity of the horizontal stabilizer is not designed for load cases induced by such a handling.

**CAUTION**

Never pull, lift or push the aircraft at the propeller spinner.

**CAUTION**

Never pull, lift or push the aircraft at the control surfaces.  
Do not step on the control surfaces.

### **8.4.2 Parking**

For short-term parking, align the aircraft into the wind, retract the flaps, set the parking brakes and chock the main wheels.

| <i>Document No.:</i> | <i>Issue:</i> | <i>Supersedes Issue:</i> | <i>Date:</i> | <i>Page:</i> |
|----------------------|---------------|--------------------------|--------------|--------------|
| FM-AT01-1010-100E    | A.12          | A.01 (05/06/2002)        | 17/09/2008   | 8 - 3        |

When parking the aircraft outside for a longer duration and in severe or unforeseeable weather conditions, additionally tie down the aircraft thoroughly. Furthermore, install the pitot-static tube cover and stall warning transmitter cover, close the canopy and cap the openings in the cowling. To avoid damage to the aircraft and its control surfaces due to gusts or strong winds, lock the control stick by pulling the stick up to the control stop and securing the stick in this position with the safety belt by closing the safety belt locking mechanism and tightening the belt straps.

However, as a basic principle, it is recommended to always store the aircraft in a hangar.

### 8.4.3 Tie-Down

The aircraft has three tie-down points; two are located on the lower surface of the wings in the outboard section (fittings with M 8 thread) and the third is located on the lower fin. For a better locating, the tie-down points are marked by placards.

It is recommended to always carry the eye-bolts delivered with the aircraft and suitable tie-down ropes in the aircraft. For protection purposes and to retain laminar airflow conditions, seal the tie-down fittings with tape before flight.

### 8.4.4 Jacking

The AQUILA AT01 is provided with 3 jack-up points. Two conical jacking points are located on the lower skin surface underneath the root ribs of the wing-body joint (see also page 2-17). Both jacking points are marked with red ring marks and by placards. The third jacking point is the lower fin skid plate under the vertical stabilizer to support the tail of the aircraft. To jack-up the tail, a tail stand with an adapter may be used placed under the lower fin skid plate and fixated to the adapter at the tail tie-down point with a fastener.

The nose wheel may be lifted off the ground for maintenance or inspection purposes by attaching weights at the tie-down point in the lower fin or using its borehole to strap down the tail. If this approach is carried out, ensure that the aircraft is sufficiently fixated and secured against falling back on its nose wheel.

### 8.4.5. Road Transportation

The aircraft may be transported in an open or closed truck trailer (with canvas top or in a container). If greater distances are to be covered by this transport, a standard semitrailer container or an ISO container with the minimum dimensions: Length = 12 000 mm, Width = 2300 mm, Height = 2350 mm should be preferably used.

For the transportation of the aircraft in a shipping unit with the above defined minimum dimensions, both, the wings and the main landing gear, must be removed. When disassembling the aircraft, the appropriate procedures defined in the AQUILA AT01 Maintenance Manual have to be precisely followed.

| <i>Document No.:</i> | <i>Issue:</i> | <i>Supersedes Issue:</i> | <i>Date:</i> | <i>Page:</i> |
|----------------------|---------------|--------------------------|--------------|--------------|
| FM-AT01-1010-100E    | A.12          | A.01 (05/06/2002)        | 17/09/2008   | 8 - 4        |

For a safe road transportation of the aircraft without any damages, special transportation jigs are required to stow the aircraft in the transportation unit. Furthermore, additional strapping and stowing means are necessary to fixate and secure the fuselage and wings during transportation such as ratchet and suitable tie-down lashing straps, fastening utilities as well as padding material.

Technical drawings on loading equipment used by the manufacturer and a loading plan can be obtained on request.

The first step in loading the disassembled aircraft into a transportation unit like a container is to stow and fixate the wing standing on the wing leading edge in an appropriate transportation jig close to the container sidewall in such a manner that the entire diagonal of the container cross-section remains available to store the airframe with the horizontal stabilizer which cannot be removed from the aircraft. Because of the limited space and the span of the horizontal stabilizer, the fuselage must be loaded and fixated with a lateral inclination (bank) angle of 45 degrees or according to the direction of the diagonal of the container cross-section.

The control surfaces and the flaps, if not fixated in the transportation jig, should be fixed and secured by means of a suitable tape or fixation clamp.

#### **8.4.5.1 Loading the Wings**

Before preparing the wing for storage and transportation, it has to be taken into account that the unsupported main spar of the wing that is removed from the airframe can absorb only limited bending loads in the chord line direction as well as torsional loads. Therefore, the manufacturer transports the wing bolted at the shear bolt attachment bushings to a support frame in the same configuration as it is attached to the fuselage. The support frame should also be used for the vertical wing storage. In this case, two padded stands with a minimum width of 100 mm in the contact area are required to support each wing half in the middle area of the half-span near the inboard kink.

If sufficient loading space is available, the wing may also be transported lying onto pads and a pallet-like support being suitable to match or compensate the wing dihedral. The exertion and application of loads on the control surfaces as well as any other installation or component protruding the surface skin of the wing structure or the root ribs must absolutely be avoided. To prevent damage to the surface of the aircraft, tie-down straps must always be padded with suitable padding materials.

If the wing has to be loaded by a crane, the wing must be fixated in the above described transport support frame supported in the same manner as installed in the airframe. Fixated in an adequate manner, the wing may be lifted at the transport support frame or with a suitable padded hoisting strap, looped around the main spar centre section. In any case, the attachment fittings and brackets installed on the wing must not be loaded.

#### **8.4.5.2 Loading the Fuselage**

The horizontal stabilizer span of 3000 mm is almost the length of the diagonal of a standard container cross-section. Therefore, the fuselage unit, including the engine, the

| <i>Document No.:</i> | <i>Issue:</i> | <i>Supersedes Issue:</i> | <i>Date:</i> | <i>Page:</i> |
|----------------------|---------------|--------------------------|--------------|--------------|
| FM-AT01-1010-100E    | A.12          | A.01 (05/06/2002)        | 17/09/2008   | 8 - 5        |

propeller, the nose landing gear and the canopy must be carefully stowed and safely fixated with an inclination angle of 45 degrees or according to the direction of the diagonal of the container cross-section. The main landing gear must be removed for the transportation because of the space limitation.

The fuselage has to be supported in front of the vertical stabilizer and at the wing attachment points. A suitable transportation jig should be used to prevent damages to the airframe. The mounting bolts at the wing attachment points must be equipped with a special coating to protect the fitting surfaces of the wing attachment points. The base of the airframe transportation jig should have a minimum width of 1200 mm and should be located in front of the forward wing attachment point to prevent horizontal tilting of the fuselage and hence damages to the airframe.

All loose items in the fuselage must be removed from the aircraft or secured in a manner that avoids damage to the structure and the systems. Additionally, the battery must be removed as well as all vents of the coolant expansion tank and the brake hydraulic fluid reservoir must be capped or plugged to avoid leaking fluids that may erode surface finishes. The propeller blades should be protected by suitable packing materials and brought in a safe position for the transport.

If the fuselage is loaded by a crane, suitable hoisting straps that are adequately padded has to be used and placed around the airframe at the firewall flange in the front section and in the area forward of the horizontal stabilizer. The hoisting straps have to be attached in such a manner that slipping of the straps as well as tilting and shifting of the airframe is not possible during the hoisting process.

## 8.5 Cleaning and Care

|                |
|----------------|
| <b>CAUTION</b> |
|----------------|

Any dirt on the surface of the aircraft deteriorates the flight performances and the flight characteristics.

### 8.5.1 Painted Surfaces

To maintain the flying characteristics and performances of the AQUILA AT01, the external surfaces of the aircraft must be kept clean and free of damages, especially in the leading edge areas of the wings and stabilizers.

Moreover, an adequate care of the painted surfaces retains the value of the aircraft.

#### 8.5.1.1 Washing

The aircraft should be washed regularly applying plenty of water and using a clean sponge and chamois leather for cleaning.

| <i>Document No.:</i> | <i>Issue:</i> | <i>Supersedes Issue:</i> | <i>Date:</i> | <i>Page:</i> |
|----------------------|---------------|--------------------------|--------------|--------------|
| FM-AT01-1010-100E    | A.12          | A.01 (05/06/2002)        | 17/09/2008   | 8 - 6        |



Heavy dirt remnants as insect residue should be immediately washed off after every flight since it is usually difficult to remove those when already dried.

Only in cases of extremely stubborn dirt, the cleaning may be performed using mild soapsuds as supportive measure since the protective coating of wax will be gradually washed away by this means.

The removal of oil and grease residues may be accomplished with a cloth sparingly moistened with benzine as a cleaning solvent. Commercially available aircraft cleaning agents also may be used since they are grease-soluble.

**8.5.1.2 Preservation**

The aircraft exterior surface is protected with a resistant and durable automotive finish. To retain its protective characteristics, it is necessary to repair minor damages to the paint as soon as practical and to wax the exterior surface of the aircraft one to three times per year using a good **silicone-free automotive hard wax**.

**CAUTION**

Only silicone-free cleaning and polishing agents may be used.

**8.5.2 Canopy**

The AQUILA AT01 canopy offers an excellent all around view due to its generous glazing made from special acrylic material.

Since acrylic glass can be easily scratched, the same basic principles apply as for the cleaning of painted surfaces. The cleaning should be accomplished by applying plenty of water and using a soft clean sponge and moist chamois leather for cleaning and drying.

For stubborn dirt residues, special well proven acrylic glass cleaners are commercially available. **Never use any solvents or thinner to clean the canopy glass.**

Minor scratches may be polished out using special acrylic glass polishing pastes available at specialised stores. For successful application, always follow the manufacturer's instruction for the proper usage of their products.

The inner surfaces of the canopy glazing are to be treated in the same way as the outer surfaces.

**8.5.3 Propeller**

Refer to latest issue of the E-124 mt-propeller Operating and Installation Manual.

| <i>Document No.:</i> | <i>Issue:</i> | <i>Supersedes Issue:</i> | <i>Date:</i> | <i>Page:</i> |
|----------------------|---------------|--------------------------|--------------|--------------|
| FM-AT01-1010-100E    | A.12          | A.01 (05/06/2002)        | 17/09/2008   | 8 - 7        |

**8.5.4 Engine**

Refer to latest issue of the Operator's Manual for all versions of ROTAX® 912s engines.

**8.5.5 Interior Cleaning**

Dust and loose dirt in the interior of the aircraft should be cleaned with an efficient vacuum cleaner. Prior to the cleaning, loose or foreign items should be removed or properly stowed away.

The floor carpets may be removed for a thorough cleaning either self-made using the same methods as for any household carpet or performed by a specialized company.

To clean plastic surfaces such as the instrument panel cover, a non-fuzzing and lightly moistened cloth should be preferably used.

The instruments may be cleaned with a dry and soft cloth.

The cleaning of the canopy is described in subparagraph 8.5.2.

| <i>Document No.:</i> | <i>Issue:</i> | <i>Supersedes Issue:</i> | <i>Date:</i> | <i>Page:</i> |
|----------------------|---------------|--------------------------|--------------|--------------|
| FM-AT01-1010-100E    | A.12          | A.01 (05/06/2002)        | 17/09/2008   | 8 - 8        |

## SECTION 9

### SUPPLEMENTS

|     |                      | Page |
|-----|----------------------|------|
| 9.1 | INTRODUCTION         | 9 -1 |
| 9.2 | INDEX OF SUPPLEMENTS | 9 -2 |

### 9.1 INTRODUCTION

In this section, all equipment that is optionally installed in your aircraft is described in terms of AFM-Supplements. Each individual supplement may be related to either a complete modification or a single built-in component or electrical equipment. Only those AFM-Supplements that apply directly to the effective equipment configuration of your aircraft must be contained in this section following paragraph 9.2.

Paragraph 9.2 "Index of Supplements" lists all existing approved AFM-Supplements established for the AQUILA AT01. This table may be also used as a directory for this section adapted to your aircraft.

If your aircraft is modified at a Maintenance Organisation outside of the AQUILA Aviation on the basis of a STC, it is within the owner's responsibility to ensure that the respective AFM-Supplement, if applicable, is inserted in this manual and properly recorded in the index of supplements in paragraph 9.2.

| <i>Document No.:</i> | <i>Issue:</i> | <i>Supersedes Issue:</i> | <i>Date:</i> | <i>Page:</i> |
|----------------------|---------------|--------------------------|--------------|--------------|
| FM-AT01-1010-100E    | A.17          | A.16 (22/07/2010)        | 07/10/2010   | 9 - 1        |

## 9.2 INDEX OF SUPPLEMENTS

|                        |                   |
|------------------------|-------------------|
| <b>Registration:</b> - | <b>S/N:</b> AT01- |
|------------------------|-------------------|

| Supplement No. | Title   | Pages          | Issue | Installed |
|----------------|---|----------------|-------|-----------|
| AVE1           | Bendix King NAV/COM KX 125                                | AVE1-1 to 8    | A.01  |           |
| AVE2           | Bendix King Transponder KT 76A                            | AVE2-1 to 6    | A.01  |           |
| AVE3           | Emergency Locator Transmitter (ELT) ACK E-01              | AVE3-1 to 4    | A.01  |           |
| AVE4           | Garmin GMA 340 Audio System                               | AVE4-1 to 6    | A.02  |           |
| AVE5           | Garmin GNS 430 GPS Navigator                              | AVE5-1 to 6    | A.02  |           |
| AVE6           | Garmin GTX 327 Transponder                                | AVE6-1 to 8    | A.02  |           |
| AVE7           | Bendix King Transponder KT 76C                            | AVE7-1 to 6    | A.04  |           |
| AVE8           | Multifunction Display/GPS KMD 150                         | AVE8-1 to 6    | A.04  |           |
| AVE9           | Emergency Locator Transmitter Pointer Model 3000-11 (ELT) | AVE9-1 to 8    | A.05  |           |
| AVE10          | Winterization Kit   | AVE10-1 to 4   | A.06  |           |
| AVE11          | Emergency Locator Transmitter KANNAD 406 AF/AF-Compact    | AVE11-1 to 10  | A.11  |           |
| AVE12          | Garmin GTX 330 Mode S Transponder                         | AVE-12-1 to 11 | A.08  |           |
| AVE13          | Garmin GNS 530 GPS Navigator                              | AVE13-1 to 8   | A.08  |           |
| AVE14          | Bendix King Transponder KT 73                             | AVE14-1 to 8   | A.09  |           |
| AVE15          | ARTEX ME406 Locater Transmitter (ELT)                     | AVE15-1 to 8   | A.10  |           |
| AVE16          | NAV/COM Transceiver GARMIN SL 30                          | AVE16-1 to 12  | A.11  |           |

|                      |               |                          |              |              |
|----------------------|---------------|--------------------------|--------------|--------------|
| <i>Document No.:</i> | <i>Issue:</i> | <i>Supersedes Issue:</i> | <i>Date:</i> | <i>Page:</i> |
| FM-AT01-1010-100E    | A.17          | A.16 (22/07/2010)        | 07/10/2010   | 9 - 2        |



| Supplement No. | Title                                      | Pages         | Issue | Installed |
|----------------|--|---------------|-------|-----------|
| AVE17          | GPS and Multifunctional Display FLYMAP L   | AVE17-1 to 12 | A.11  |           |
| AVE18          | FLARM Collision Warning System             | AVE18-1 to 10 | A.11  |           |
| AVE19          | Flight Data Logger KAPI Air Control FDR 07 | AVE19-1 to 8  | A.11  |           |
| AVE20          | Mode S Transponder GARMIN GTX 328          | AVE20-1 to 10 | A.11  |           |
| AVE21          | COM Transceiver GARMIN SL 40               | AVE21-1 to 10 | A.11  |           |
| AVE22          | GARRECHT VT-02 Mode S Transponder          | AVE22-1 to 9  | A.01  |           |
| AVE23          | Day-VFR and Night-VFR-Operation            | AVE23-1 to 18 | A.02  |           |
| AVE24          | ASPEN EFD 1000 – PFD                       | AVE24-1 to 9  | A.01  |           |
| AVE25          | ASPEN EFD 1000 – MFD                       | AVE25-1 to 9  | A.01  |           |
| AVE 26         | GARMIN G500 PFD/MFD System                 | AVE26-1 to 10 | A.02  |           |

The Equipment signed by „Installed“ are installed and the associated supplements are inserted.

\_\_\_\_\_

Date

\_\_\_\_\_

Sign

| Document No.:     | Issue: | Supersedes Issue: | Date:      | Page: |
|-------------------|--------|-------------------|------------|-------|
| FM-AT01-1010-100E | A.17   | A.16 (22/07/2010) | 07/10/2010 | 9 - 3 |